

Agilent MIMO Wireless LAN PHY Layer [RF] Operation & Measurement

Application Note 1509

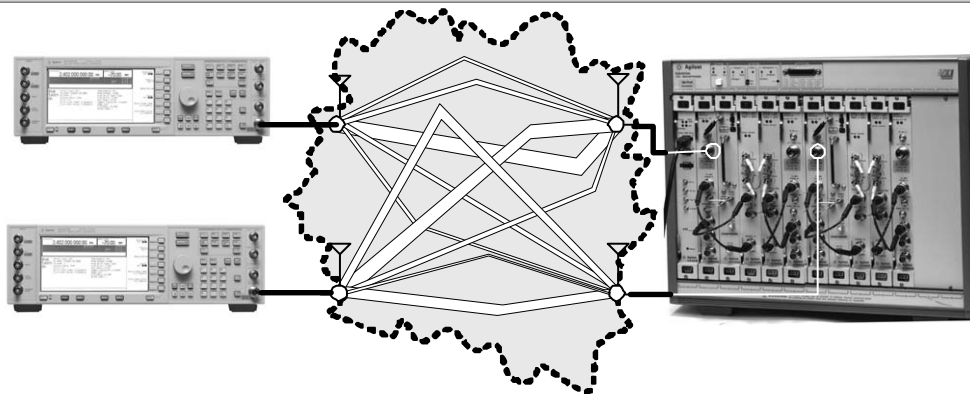
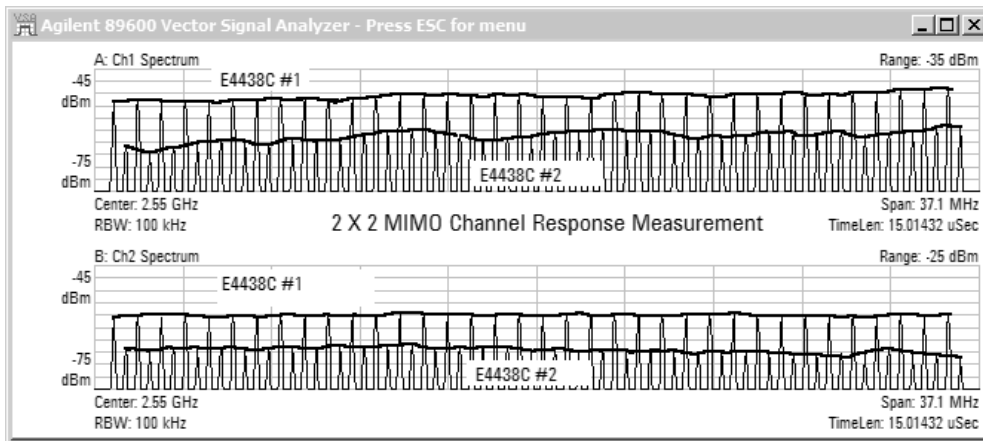
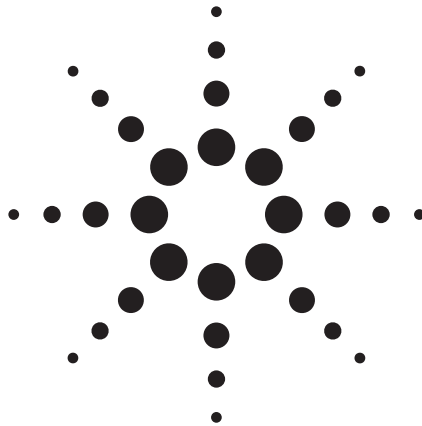

Introduction

This application note is written for people who need an understanding of MIMO radio operation as it applies to WLAN, and the test configurations for multi-channel radios.

Increasing use of wireless systems and new applications like digital video streaming mean a continued desire for higher throughput or better coverage from radio systems. To some extent, the use of more complex modulation formats such as Orthogonal Frequency Division Multiplexing (OFDM) and 64 QAM has satisfied this need, but further advances are being made. Changing the use of the spectrum available is being pursued in several ways. Ultra-Wideband (UWB) is one approach for increasing throughput; another is called Multi-Input Multi-Output radio (MIMO)¹.

MIMO radios get more from the RF bandwidth they occupy than their single channel equivalents, by exploiting differences in the paths between each of the transmitter and receiver inputs. If a conventional single channel radio system creates one “pipe” between the transmitter and receiver, the object of a MIMO radio system is to create multiple pipes. It does this by creating a mathematical model of the paths from transmitters to receivers, and solving the resulting equations. If the pipes can be completely separated, the channel capacity increases linearly as more transmitter-receiver pairs are added.

A channel with more capacity does not mean it can only be used to transfer data at a higher rate. If the same user data is sent over all the pipes, the path diversity improves, and there is a greater chance it will be recovered successfully. This is a good match for WLAN applications operating at 5 GHz, where there is under-used spectrum, but the operating range can be restricted. MIMO at 5 GHz offers a way to open up this unlicensed band more fully, and is one of the key themes of the IEEE 802.11n specification.

The objective of the IEEE 802.11n wireless LAN specification is to increase the user data rate beyond 100 Mbps. When completed, it will contain a number of options that allow for extensions to rates far beyond this. The increased throughput will come from a mixture of changes to the way data packets are sent, along with use of sophisticated radio techniques that demand high performance from the RF hardware.

The IEEE group is not the only body interested in the development of MIMO radio. In Europe, the Marquis project is developing advanced techniques, and cellular specifications, such as HSDPA, are beginning to add extensions to allow for multi-channel capabilities. The Wireless Gigabit with Advanced Multimedia Support (WIGWAM) project seeks 1 Gbps throughput.

The radio environment does not give up increases in capacity easily. MIMO radio operation relies on the ability to separate the “pipes”. Like a solution to a mathematical puzzle, there have to be enough equations compared to the number of unknowns. This is added to the usual requirements to deal with matters of interference, noise, interoperability, hardware costs and current consumption.

Testing will play an important part in helping to make sure the radios operate correctly, both individually, and between the many different designs that will be developed.

This application note begins with a brief description of the fundamentals of MIMO operation. A variety of tests are then described, some of which are generically applicable and others more targeted at the future 802.11n specification. Suitable equipment from Agilent Technologies is presented. Finally a number of annexes provide a range of reference material.

1. Pronounced 'my-mo.

Table of Contents

1. Changes Needed in WLAN Operation to Reach 100 Mbps Throughput	4
2. Multi-Channel Radio and Spatial Streams – MIMO	6
2.1. Terminology	6
2.2. Concept of operation	6
2.2.1. Extended packet structure	10
2.2.2. Channel estimation	11
2.2.3. Code Division Multiple Access (CDMA) compared to MIMO	11
2.3. The Radio Channel	12
2.3.1. Modeling the radio channel	12
2.3.2. Measuring & applying real channels	13
3. Multi-Channel Radio applied to WLAN	14
3.1. Orthogonal Frequency Division Modulation (OFDM) refresher	14
3.2. Diversity techniques	14
3.2.1. Switched receiver	15
3.2.2. Switched transmitter	15
3.2.3. Space time block coding	16
3.3. Spatial division multiplexing	17
3.4. Beamforming	18
3.4.1. Phased array	18
3.4.2. Spatial channel beamforming	19
3.4.3. Closed loop spatial channel beamforming	20
4. Radio Block Diagram	21
5. Transmitter Testing	23
5.1. Single channel measurements	23
5.1.1. Power, power versus time, CCDF	23
5.1.2. Spectrum	24
5.1.3. Auto-correlation	26
5.1.4. Frequency & phase settling, EVM	27
5.2. Two channel measurements	29
5.2.1. Using an oscilloscope as a digitizer	30
5.2.2. Coherence	30
5.2.3. Cross correlation	31
5.2.4. Other two channel measurements	32
5.3. Going beyond two channels	33
6. Receiver Testing	34
6.1. Single source	35
6.1.1. Sensitivity improvement over SISO radio	35
6.1.2. The keyhole method	35
6.2. Multiple source	35
6.2.1. Requirement for independent or common local oscillator	36
6.2.2. Phase synchronous RF signal generation	36
6.2.3. Using an offset IF to create two signals from one AWG	36
6.2.4. RF amplitude correction in the E4438C	39
6.2.5. Other receiver testing	39
Appendix A: Agilent Solutions for Multi-Channel Signal Generation and Analysis	40
Appendix B: Recommended Reading	44
Appendix C: Glossary	45
Appendix D: Symbols and Acronyms	46
Appendix E: References	47

1. Changes Needed in WLAN Operation to Reach 100 Mbps Throughput

A combination of signaling protocol changes and multi-channel radio techniques provide the path to much higher performance WLAN systems.

It is well known that the peak data rates associated with current WLAN OFDM technologies, such as IEEE 802.11a, do not reflect the throughput available to the user. As shown in Figure 1, the rate refers to the coded bits in the payload of the packet. There is a relatively large amount of time spent not transmitting at this rate. Hence the maximum data throughput is typically 30 to 40% of the headline rate.

To address the overheads in the packet transfer mechanisms, changes are being made to the Medium Access Control, MAC. An example is packet aggregation where the spacing between periods of data transmission is kept to a minimum, and the number of acknowledgement packets is reduced, by Block Acknowledgement.

An alternative is to increase the maximum payload. In practice the radio environment restricts how long it is possible to transmit continuously. This is because the path between the transmitter and receiver is constantly changing, and the adaptation to a particular condition may only last a few milliseconds. Sending multiple individual packets with a partial header is a further possibility that may suit most needs.

Worthwhile improvement can also be made by making a small increase in the number of OFDM sub-carriers, halving the OFDM guard interval or reducing the number of pilot sub-carriers. If implemented, these will increase throughput without adversely affecting the channel bandwidth.

A number of new protocol management packets are also proposed to support the MAC and PHY changes. A *reduced interframe spacing, RIFS*, may also be introduced.

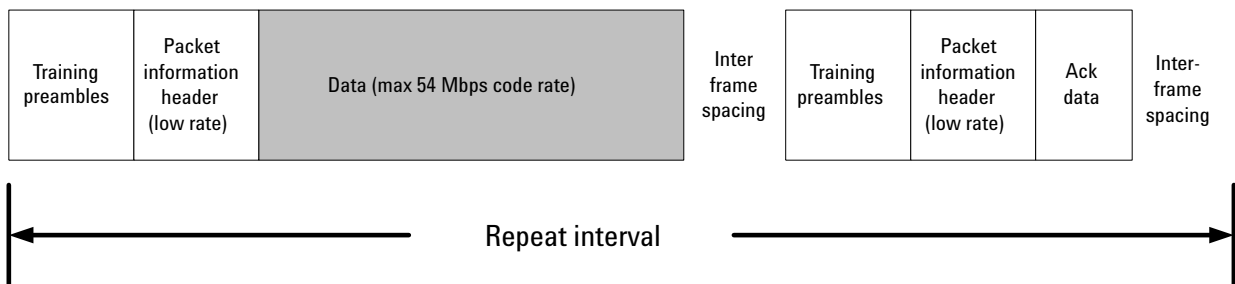

Figure 1. Simplified WLAN OFDM packet timing.

Once the packet structure is improved, it makes sense to consider the improvements possible for the radio performance. There are three ways to do this. The standard equation for channel capacity indicates two of them:

$$C = B \cdot \log_2(1 + \rho)$$

where

C = Channel capacity (bits/second)

B = Occupied bandwidth

ρ = Signal to noise ratio, SNR
(linear ratio, not dB)

Equation 1. The expression for single channel capacity

Increasing the occupied bandwidth or improving the signal/noise (S/N) ratio increases the channel capacity.

First, if we modulate data onto the RF carriers at a faster rate, we transfer data more quickly, but directly increase the occupied bandwidth. This method is already used in some WLAN devices, which double the clock rate in the transmitter baseband. A modification of this idea will be made an option for 802.11n devices. The drawback is that some spectrum regulatory authorities prohibit doing this. In situations where there are a number of different generation Access Points running independently, it may not allocate spectrum capacity in the most effective way.

The second technique is to improve the signal/noise ratio, which allows the use of a more complex modulation format. In principle, going from the current 64 QAM to 256 QAM could significantly improve throughput with no increase in the occupied bandwidth. In practice there are difficulties both in improving the signal/noise at the receiver and generating 256 QAM. Worthwhile improvements in SNR can be made using multiple receivers and employing diversity, but the hardware performance required for processing a 256 QAM signal has involved additional costs. Even when the S/N ratio can be improved sufficiently, the throughput only increases on a logarithmic basis.

The performance of future IC technology may allow more complex modulation, but there is a third approach we can take for increasing capacity, based on the use of MIMO techniques.

2. Multi-Channel Radio and Spatial Streams – MIMO

2.1. Terminology

There are many “smart antenna” and multi-channel technologies in use or being considered. It is important to make sure common terminology is being used. If a radio system has more than one antenna at both transmitter and receiver, it may be multi-channel, but it does not mean it is using spatial division multiplexing. The number of inputs and outputs to the radio channel determine what kind of radio is possible. The term MIMO refers to where two or more **simultaneous** channel inputs and channel outputs are being used, see Figure 2.

Spatial division multiplexing needs to be employed to deliver the capacity gains described in equation two.

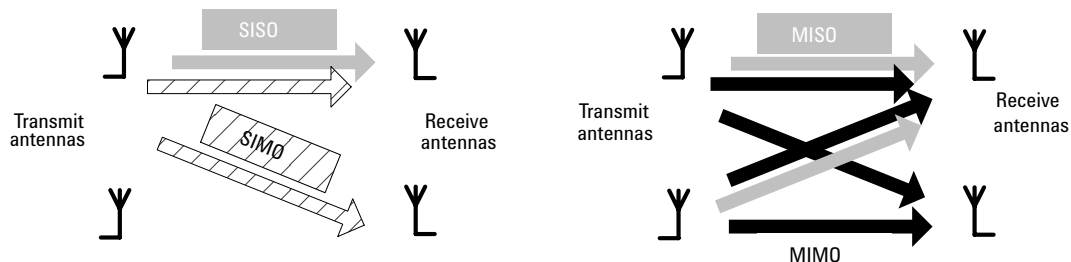

Figure 2. Radio technology definitions are based on the type of channel being used.

2.2. Concepts of operation

The IEEE 802.11n task group has turned to a more advanced radio system, called Multi-Input Multi-Output, or MIMO. It is a technique that allows us to send data streams in parallel, conceptually as if we were using cables instead of radio. The reason we can do this is because the characteristics of the typical WLAN radio path between two antennas are a strong function of exactly where the antennas are placed. If you move an antenna a few centimeters (half a wavelength), different coefficients apply for the equation that defines the new path. The differences mathematically separate the signals. This gives rise to the concepts of *spatial separation* and *spatial streams* of data, brought about by the physical separation of the antennas.

If we transmit from a number of antennas at the same time, we get a series of equations describing what the channel looks like between the combined paths. Once we know the transfer characteristics of the channel, we can work out how data that has been transmitted together will have been combined on the way to the receive antennas.

Mathematically, the summation sign in Equation 2 shows the capacity increasing linearly with the number of transmit-receiver chains, N . For the gain to be realized, each transmit-receive chain must be used for the same signal, at the same time. It is an extension of Equation 1, and introduces a new variable, $\sigma_1^2(H)$. These are the *singular values* of the radio channel, and are a metric for the MIMO capacity of the channel.

They are fundamental in determining how much improvement in capacity can be achieved for a given radio environment.

$$C = \sum_{i=1 \text{ to } N} B \cdot \log_2 \left(1 + \frac{\rho}{N} \sigma_i^2(H) \right)$$

where

N = the number of independent transmitter-receiver pairs
 $\sigma_i^2(H)$ = the singular values of the radio channel matrix, H

Equation 2: The expression for MIMO capacity

It looks, and is, more complex than conventional radio, but the key advantage is being able to transmit data at a considerably higher rate without using more bandwidth, or requiring a better signal/noise ratio.

Note 1: A more generalized representation is to replace N with $\min(N, M)$ where N is the number of transmitters and M is the number of receivers.

Note 2: The transmit power has been equally divided amongst the transmitters, therefore the SNR for an individual path is degraded, but the loss in capacity is only on a logarithmic basis.

For a given square matrix, \mathbf{A} , the singular values are the square roots of the eigenvalues of $\mathbf{A}^H \mathbf{A}$, where \mathbf{A}^H is the conjugate transpose (Hermetian) of \mathbf{A} . The simplest way of thinking of the singular values is to consider them as a measure of how strong and how well separated the spatial channels are. The best MIMO channels have large singular values of equal size.

There are several ways the channel coefficients can be found. Looking at Figure 3, the simplest to understand is to transmit a pair of known and different signals at T_0 & T_1 , and measure what appears at R_0 and R_1 . It is an example of *non-blind* channel extraction. The *training* period of operation is quite distinct from the time when user data is sent. It is the technique proposed for 802.11n operation, and is an extension of the multi-tone channel estimation approach used in 802.11a.

In Figure 3, inputs T_0 & T_1 represent the signals transmitted over the radio channel. The coefficients in the example represent the frequency independent path losses and the cross coupling on the way to the receiving antennas at R_0 and R_1 .

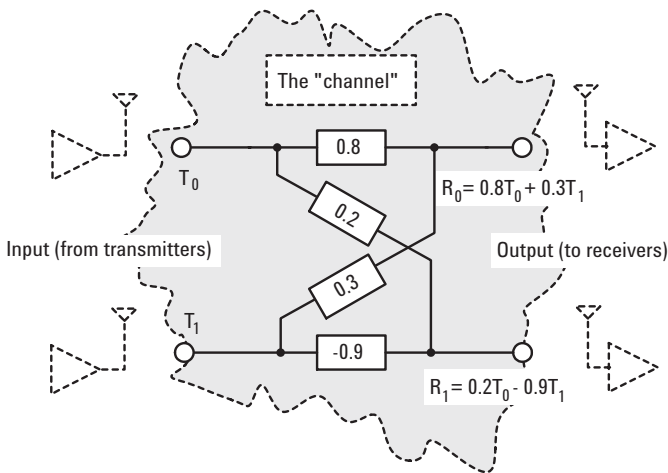

Calculate input from output:

$$\begin{aligned} T_0 &= 1.15R_0 + 0.39R_1 \\ T_1 &= 0.26R_0 - 1.03R_1 \end{aligned}$$

Re-written in matrix form as

$$\begin{bmatrix} T_0 \\ T_1 \end{bmatrix} = \begin{bmatrix} 1.15 & 0.39 \\ 0.26 & -1.03 \end{bmatrix} \begin{bmatrix} R_0 \\ R_1 \end{bmatrix}$$

Figure 3. A much simplified 2*2 MIMO channel example, intended to help remove some of the mystery about MIMO operation.

If, during a training period, T_0 and T_1 are known and different, the coefficients in the channel can be calculated by measuring the two signals at the receiver inputs.

Solving the resulting simultaneous equations reveals the channel coefficients, which can then be used to reconstruct the original data.

Clearly, the coefficients don't represent a realistic channel, but the purpose is to show how we can use the received signals, R_0 and R_1 , to calculate the channel coefficients.

At this point, it is worth considering if MIMO techniques can provide capacity gains under all channel conditions. The answer is no. Using the previous simplified example, we can get an idea why this is.

The singular values of the channel in the example of Figure 3 are 0.957 and 0.815. This is a very good MIMO channel, since that ratio of the values is nearly 1 (1.17). Table 1 shows how the situation changes as the coefficients in one of the links changes. Phase differences become very important if the coupled and direct coefficients are similar in value.

Table 1. Variation in singular values as channel coefficients are altered

$T_1 - R_1$ coefficient	Singular values		Ratio (low = better)	Comment
-0.9	0.96	0.82	1.2	A good channel
0.9	1.1	0.6	1.9	Some degradation with loss in phase differentiation
-0.3	0.86	0.35	2.5	Degradation due to weaker direct coefficient
0.3	0.9	0.2	4.6	Much poorer channel due to combination of effects

The accuracy of the channel estimation is vital to accurate signal recovery. It can be degraded for a variety of reasons including noise in the channel, distortion and quantization errors. To remind us of the need to deal with noise, a more complete expression for the received signals in Figure 3 would be:

$$\mathbf{R} = \mathbf{H} \mathbf{T} + \mathbf{n}$$

where

\mathbf{H} is the matrix of channel coefficients

\mathbf{n} is the matrix of noise factors

\mathbf{R} and \mathbf{T} are the matrices describing the received and transmitted signals

The effect of thermal and quantization noise on channel extraction process has a major impact on the design of the WLAN packet, and the radio digital signal processing (DSP).

Another way to consider the channel operation is shown in Figure 4. The lines in the Figure represent the equations for R_0 and R_1 . The crossing point of the lines represents how accurately we can find the coefficients. In the top left, the lines are precisely known, equivalent to a high signal to noise ratio. The lines are nearly orthogonal (at right angles to each other). We can determine the crossing point very accurately, which indicates accurate solutions to the channel equations.

In the bottom left, the lines have been made less distinct, to indicate a signal with a poor signal to noise ratio. The lines still cross nearly orthogonally, so it is still possible to get a fairly accurate answer for the crossing point. In the top right, the angle between the lines was considerably reduced. The area in which the lines are crossing has increased significantly, making the estimate of the slopes much less precise. Finally, in the bottom right, additional lines are added, to represent more equations, which was created using more antennas. The use of additional lines (equations) helps recover some of the resolution in the location of the crossing point.

If reflections are not able to form part of the propagation path, the channel coefficients are more likely to be similar (correlated). The *keyhole* channel is an example of where this happens. Visualizing the channel as containing a small window (aperture) may be useful. In practice, other structures, like metal roof lines can cause the diversity in the channel paths to be reduced with the same end result – a reduction in the MIMO capacity.

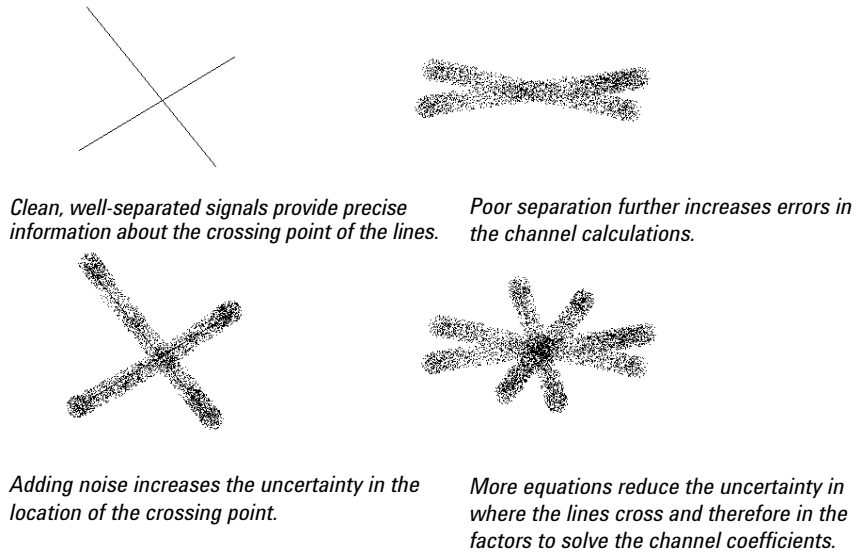

Figure 4. Errors in MIMO signal recovery depend on how different, and how noisy the channel is. The lines in this figure represent the equations used to calculate the channel coefficients.

2.2.1. Extended packet structure

The MIMO channel estimation process requires an extension to the preamble techniques used for 802.11a. Additional training periods allow the receiving device to calculate the channel coefficients. One proposal for the construction of a high throughput WLAN packet is shown in Figure 5.

During the data part of the burst, information is mapped to individual transmit channels. As part of this process, there is a rotation in the sub-carriers used on different antennas. This is not required for Spatial Division Multiplexing (SDM) operation, but improves the robustness of the signal.

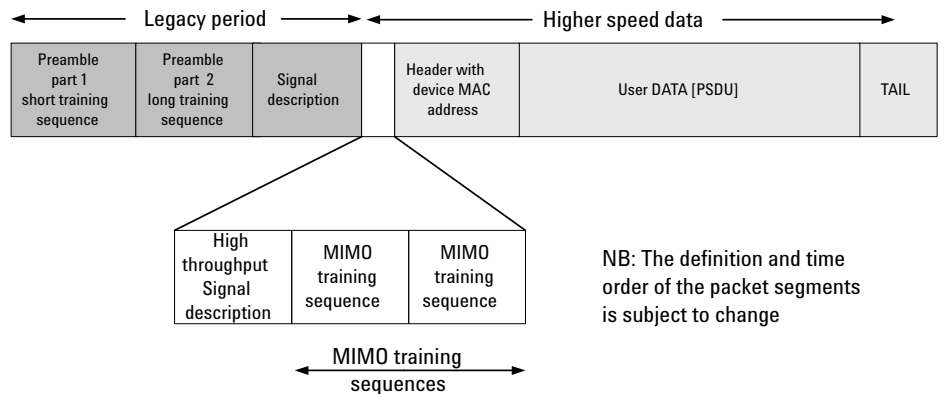

Figure 5. WLAN packet modifications to allow for MIMO operation. Greenfield¹ or Pure Mode² packets do not require the legacy period, and will offer increased throughput.

1. WWiSE Proposal: High Throughput Extension to 802.11 standard IEEE 802.11-05/0149r5.
 2. TGn Sync Proposal Technical Specification IEEE 802.11-04/0889r7.

2.2.2. Channel estimation

One of the visually most intuitive methods for MIMO channel estimation works by transmitting interleaved sets of sub-carriers from each transmitter. The test configuration in Figure 6 shows one way the channel information may be extracted. The same 1 MHz spacing multi-tone signal is generated in the two signal generators. The center frequency of one generator was offset by 500 kHz. The four frequency responses shown in the right of the diagram show visually how the different path responses can be isolated.

The training periods are designed to have strong time-correlation properties, and minimize the peak to average power of the signal at the transmitters. During the training sequences, the analog gain control in each radio receiver channel means only one setting can be used to measure the coefficients from all the transmitters. We can only measure the ratio of the signals from different transmit antennas. If it is significantly different, there will be quantization errors in the weaker signal. While this might not appear to be a serious issue, it means the channel would be poor for MIMO transmission.

Absolute gain differences between the input channels may not be important, but the gain setting in the receiver chains has to be as accurate as possible to maximize the use of the ADC resolution for the calculation of the channel.

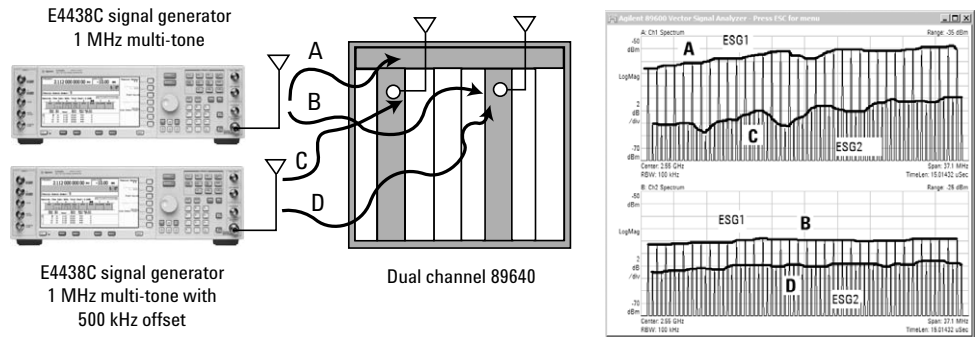

Figure 6. Example of the four channel frequency responses, found using interleaved multi-tone signals from two E4438Cs, and received on a dual channel 89640 VXI system.

2.2.3. Code Division Multiple Access (CDMA) compared to MIMO

At a superficial level the operation of a CDMA radio, where multiple users share the same bandwidth, bears some resemblance to MIMO. However, the two systems are quite different. MIMO radio increases the channel capacity, where CDMA does not. As the acronym tells us, CDMA is a multiple access technology, where at any instant the signal for each user is individually recoverable. In MIMO, the radio must be able to simultaneously receive more than one signal to make use of the channel capacity gains.

In CDMA, each user's signal is isolated from the other by a unique code. Codes are designed to be different (orthogonal) in a way that allows the receiver to isolate just one signal, while the others look noise-like. As the number of users increases, the effective noise level rises. The total system capacity is reached when a receiver can no longer effectively recover the bit stream it is targeting.

In a MIMO system, the additional transmit-receive chains (critically including physically separated antennas) use the spatial diversity of the radio environment to actually increase the total capacity. The total system capacity is reached when the entire channel's spatially separated variables with a useful signal to noise ratio are being used.

Unlike CDMA, a MIMO system does not require the data signals to be orthogonal.

2.3. The radio channel

The nature of the RF path, or channel, determines of the performance of a MIMO radio system.

2.3.1. Modeling the radio channel

A model of the radio channel is needed both to compare the performance of different radio simulations, and for creating test signals to use with real devices.

The Medbo-et al based model, with its five profiles (models) to suit different environments is used for existing WLAN performance analysis. The 802.11n task group has expanded it, and a more sophisticated model developed for use with MIMO radio¹.

For example, the angular spread of the signals becomes very important, as it affects the way a signal will be affected differently as it travels from each of the transmit to each of the receive antennas. Signals are considered to arrive in *clusters*, where each cluster represents signals with a straight line connecting their path loss (in dB) as a function of time delay.

There are environment-specific effects such as the "*fluorescent light*" effect¹, which need to be dealt with too. Some may result in the channel changing during the course of an individual data packet.

The Agilent Advanced Design System software is a flexible environment, where the interaction between hardware and channel simulations can be comprehensively analyzed.

1. TGN channel models IEEE 802.11-03/940r4.

2.3.2. Measuring & applying real channels

Published channel models tend to be used as a basis for comparison of WLAN systems, rather than be intended as a complete design test. They may not be representative of a specific environment.

The channel can be measured using a vector network analyzer or a combination of arbitrary waveform generators (AWGs), signal generators and RF digitizers. If an AWG is available, a variety of waveforms can be used, including multi-tone and frequency chirps. The main requirement is that the test signal maximizes the measurement time available, commensurate with the channel remaining stable. Minimizing the peak/average of the signal, is done using a Golay sequence for the real preamble signals, which ensures the test receiver input sensitivity is kept as high as possible. Signal recovery software will need to be written to suit the test signal.

One technique for reproducing a signal that is known to cause problems is to make an RF recording, as shown in Figure 7. The 89600 vector signal analyzer (VSA) software makes this very straightforward for two channels. The 89640 hardware allows for multi-second recording intervals. Custom software may be used to increase the number of channels captured. This technique was used in the example of Figure 6.

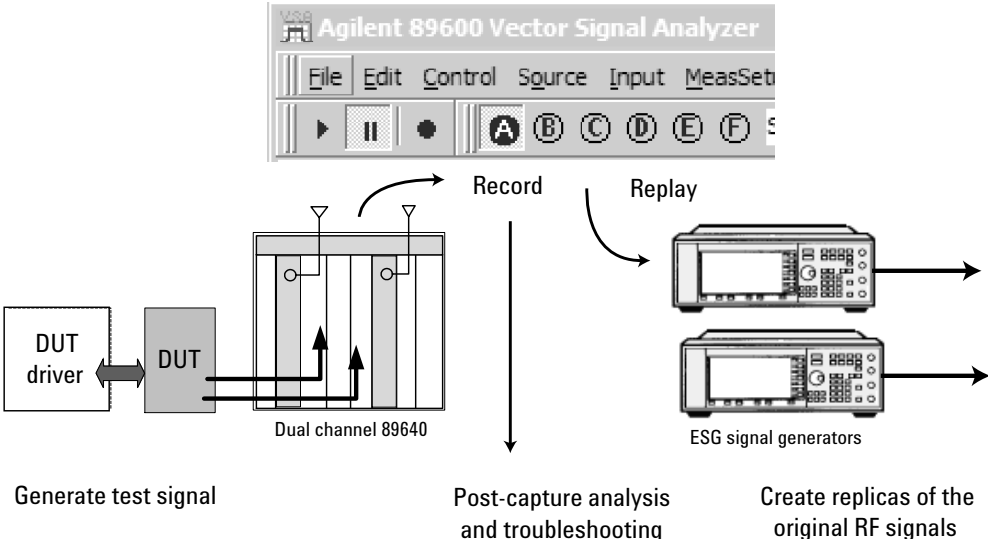

Figure 7. Recording live MIMO test signals for use in troubleshooting.

3. Multi-Channel Radio Applied to WLAN

There is a strong link between the use of 802.11a style OFDM and MIMO operation. This applies all the way through the designs. In order to understand how OFDM is adapted for MIMO, it is useful to consider what is in a Single Input Single Output (SISO) radio

3.1. Orthogonal Frequency Division Modulation (OFDM) refresher

OFDM shares the high-speed data input across many sub-carriers. This has the effect of reducing the bandwidth needed for the individual sub-carriers. Data is collected into blocks of data (symbols), which are encoded for error protection and then spread (interleaved) across the sub-carriers in a way that protects them against the loss of a small number of sub-carriers due to multi-path cancellation or narrow band interference. The *orthogonal* label refers to the way the frequency spacing of the sub-carriers and data modulation rates are chosen to avoid interference between the sub-carriers.

The bandwidth for each sub-carrier is narrow, but there is still a delay associated with it. A guard interval inserted between the symbols allows for the longest delay expected in the system design. During the guard interval, the symbol is extended at the beginning with a copy of the same period of time from the end of the symbol. This period is referred to as the cyclic prefix or extension.

WLAN transmission works on the basis of isolated packets being recovered using only the information within that packet. At the start of the packet (burst), there are two training periods. During the first 8 μ s short training sequence every 4th sub-carrier is turned on, with a phase relationship that minimizes the peak to average power ratio. This period is used for gain setting in the receiver, and for coarse frequency corrections. During the next 8 μ s, the long training sequence, all the sub-carriers are turned on to allow the receiver to calculate the frequency response of the channel and fine tune frequency errors.

Using OFDM allows us to make some important assumptions about the signal for MIMO operation. For example, the modulation bandwidth for each sub-carrier is small enough to assume the RF path can be represented by a single complex coefficient. This is what makes calculations of the channel coefficients for MIMO operation realistic for low cost DSP implementations.

3.2. Diversity techniques

Diversity techniques are used for reducing the errors in the transfer of a single data stream.

Antenna spatial diversity is not a new theme and it has been used in many WLAN devices already. The multiple transmit-receive pairs that will be found in 802.11n devices may be configured for diversity improvements, as an alternative to an increase in capacity.

Making use of path diversity gives an increase in the robustness of the signal path. This means there will be an increase in the maximum data rate at any given distance. If the signal to noise performance is better than required, it will be possible to reduce the transmit power and extend the battery life of portable devices.

3.2.1. Switched receiver

As soon as the packet arrives at the receiver, the Automatic Gain Control (AGC) circuit starts to act. A simple technique is to switch to the second antenna if the signal amplitude is estimated to be too low to use reliably. This is still a SISO radio, because only one receiver chain is available.

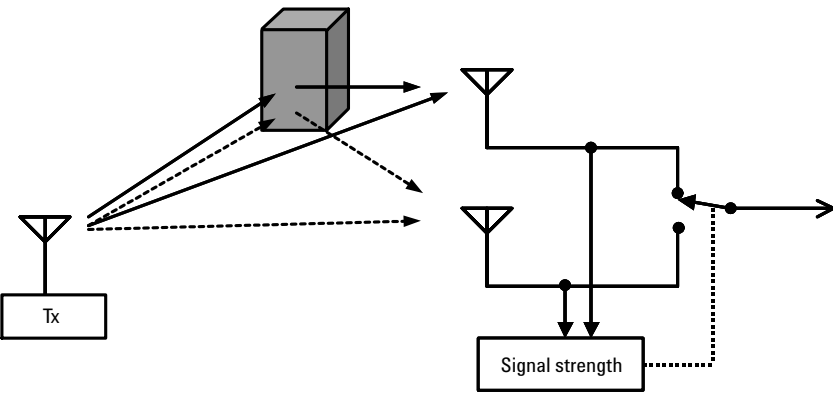

Figure 8. Switched receiver diversity.

3.2.2. Switched transmitter

The radio has to decide which antenna to use. This may be done using a simple trial-and-error approach, where the same antenna is used until a packet error is received. The key difference compared to the switched receiver, is that the transmitter has at least some primitive knowledge of the channel, i.e. which antenna path is better. It is the first step in applying *channel knowledge*.

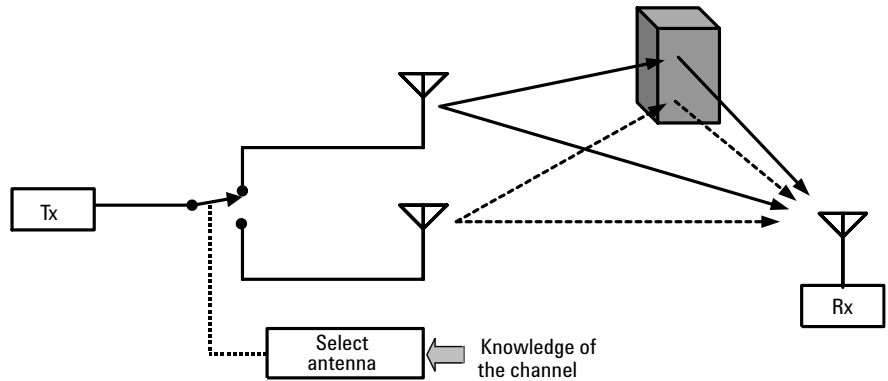

Figure 9. Switch transmitter diversity.

3.2.3. Space time block coding

The next step in complexity is to use the antennas simultaneously instead of switching them. This requires a doubling of the hardware in the transmit chain, but can give some useful performance gains. In particular, as *Alamouti* demonstrated, it is possible to get the same performance using space time block coding with two transmit antennas, as it is using maximum ratio combining with two receive antennas. This is important for cellular radio, where additional complexity can more readily be added at the base station. It also has benefits for 802.11n WLAN applications, where the physical issues of mounting two antennas in a device, or the cost of doing so may be prohibitive.

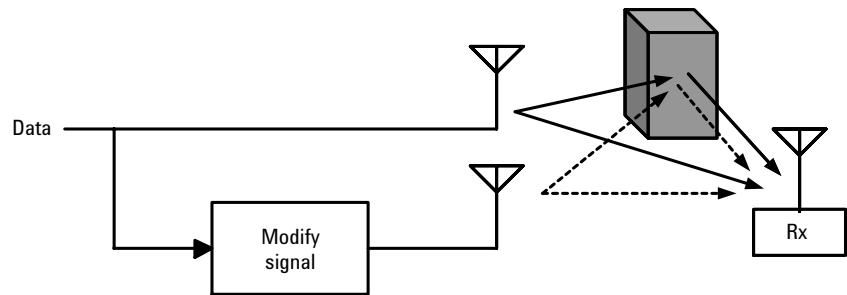

Figure 10. Time coding signals for two antennas.

When an 802.11n device is transmitting a legacy signal, like 802.11a or b, a choice has to be made whether to only use one transmitter, or to split the signal between both chains. In most cases the signal will be sent down both transmit chains. Unless one of the signals is modified, the result will be a simple type of beamforming. The way this is avoided, is through the use of a *cyclic shift*. A delay is inserted into one of the signal paths. There may be some conflicting requirements on the length of the delay, but it will usually be between 50 to 200 ns. This delay gives a frequency dependent phase shift between the signals on the two antennas.

Space time block coding is a Multiple Input Single Output (MISO) technique, used to generate a more robust transmission path. It is of interest for 802.11n because some device arrangements may be asymmetric, and have only a single antenna at one end of the link.

The “space” refers to the different location of the antennas. In the Alamouti example of Space Time Block Code (STBC), the “time” refers to the reversal of the transmission time of pairs of OFDM symbols. In Figure 11, examination of the transmitted signals shows the additional phase rotations applied to the signals on each channel. Pairs of symbols have to be recovered and processed together in the receiver.

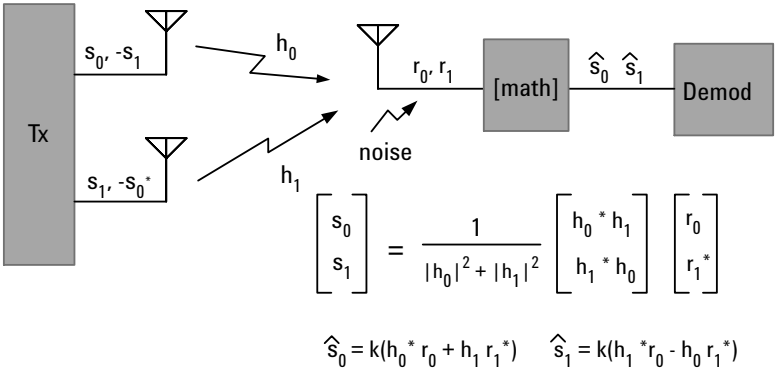

Figure 11. OFDM symbol manipulation used in space time block coding.

3.3. Space division multiplexing

The final method for using multiple channels is the one that gives the increases in instantaneous capacity.

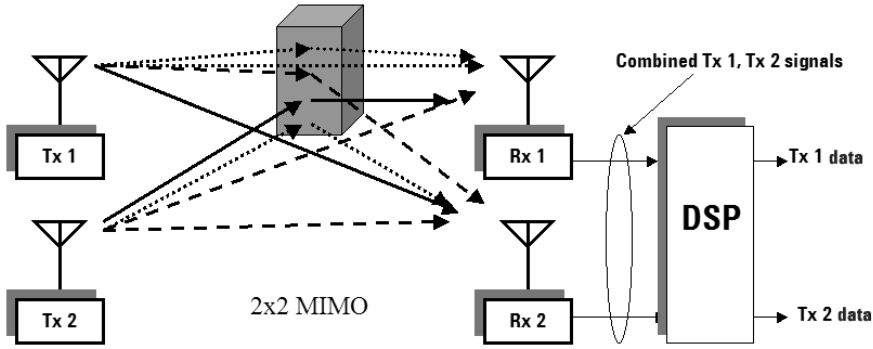

Figure 12. Simplified representation of 2*2 SDM MIMO radio system.

3.4. Beamforming

The phrase “beamforming” used in reference to MIMO Spatial Division Multiplexing (SDM) is different to the beamforming often associated with a phased array antenna system. Both effects are important in MIMO WLAN design, but for different reasons.

3.4.1. Phased array beamforming

A phased array antenna is normally associated with line of sight (LOS) transmission. Often it is applied to single carrier modulated signals. It can be applied at the transmitter or receiver. Like a high K channel, a phased transmit array is likely to degrade spatial channel performance.

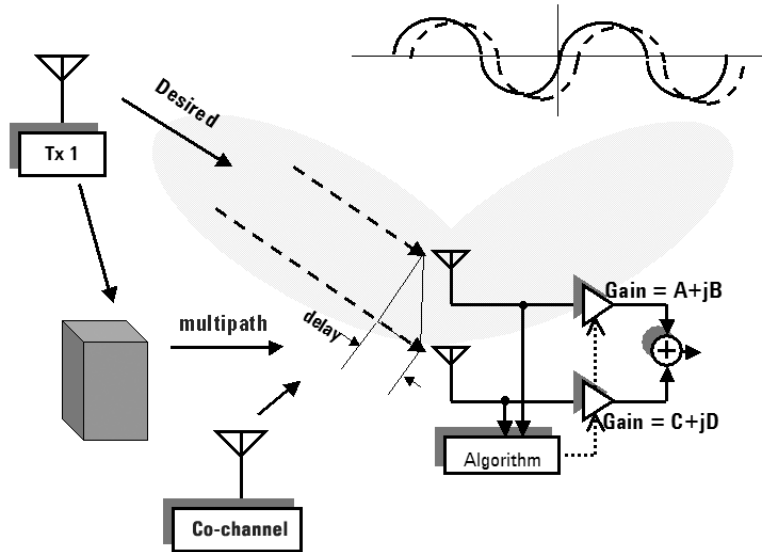

Figure 13. Phased array receiver antenna.

If it is used in a mobile application, this kind of beamforming requires a regular scanning mechanism like an omni-directional beacon, to allow the devices at the end of the link to locate and track each other.

In a receiver array, interference rejection can be as important as the increase in the wanted signal level. If the same signal is transmitted from two or more antenna simultaneously, the signal strength at any receiving location depends on phase alignment of the incoming signals.

3.4.2. Spatial channel beamforming

Spatial channel “beamforming” (SCB) is equivalent to reducing the “fuzziness” of the lines in Figure 4 which is achieved by increasing the transmit power applied to the signals that make up those lines. It can take several forms, depending on the complexity of the implementation, and is reported to particularly suit designs with more transmit than receive antennas.

SCB requires the transmitting device to know what the channel looks like, i.e. to have *channel state information* (CSI), and an assumption that the channel is *reciprocal*, i.e. the same in both directions. Mathematically, the uplink channel matrix needs to be the transpose of the downlink channel matrix.

CSI is provided in the long training sequence of the preamble every time a device gets a packet from the other end of the channel. Errors in recovering CSI, due to noise or a lack of reciprocity, will degrade spatial channel beamforming system performance.

The “beam” applies to a particular spatial channel, **not** a beam in the phased-array sense. Since the spatial channel is the result of a combination of antenna positions and the physical environment, it means there are only certain physical locations that will benefit from the “beam”. See Figure 14.

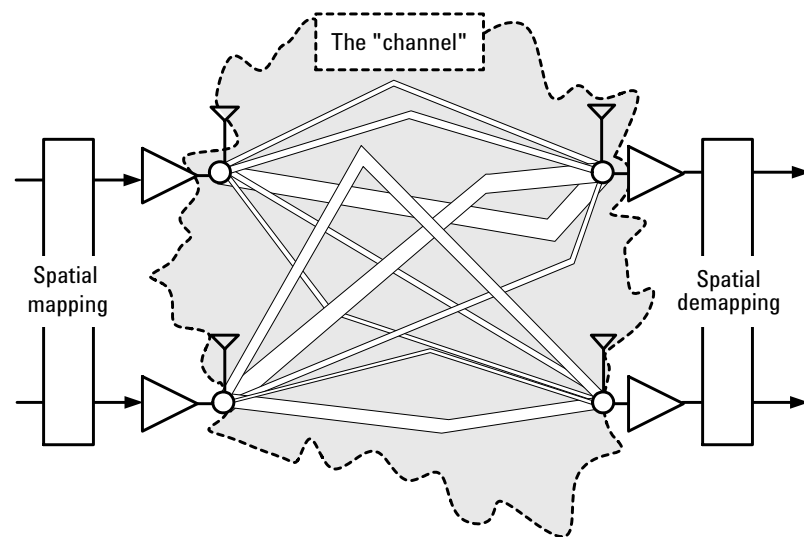

Figure 14. Individual paths between the transmit and receive antennas will have different performance – shown here as the width of the lines. Spatial beamforming uses this channel knowledge to calculate how to apply the transmitted power.

The channel will generally be the combination of multiple reflections, so the beam cannot be visualized in the same way as the phased array. The beam is created as the combination of complex coefficients applied to each OFDM sub-carrier.

Beamforming means the MIMO processing is split between the transmitter and the receiver. Since we anticipate adding some kind of pre-coding to the transmitted signal, we go back to the general expression for received signal to find out how to apply it. Mathematically, it is convenient to replace \mathbf{H} with three matrices, \mathbf{UDV}^H as follows:

$$\mathbf{R} = \mathbf{HT} \quad \text{becomes} \quad \mathbf{R} = \mathbf{UDV}^H \mathbf{T}$$

\mathbf{U} and \mathbf{V} are chosen so that $\mathbf{UU}^H = \mathbf{VV}^H = \mathbf{I}$, and \mathbf{D} is “diagonal”, which means all but the leading diagonal elements are 0. This means the singular values of \mathbf{D} will be equal – giving the optimum MIMO capacity for any particular \mathbf{H} . Now we pre-code the signal at the transmitter, with \mathbf{V} , and post-code at the receiver with \mathbf{U}^H .

$$\mathbf{U}^H \mathbf{R} = \mathbf{DVT}$$

The “pre-coding” is the spatial channel beamforming function. One of the methods for calculating the coefficients is known as *singular value decomposition*.

3.4.3 Closed loop spatial channel beamforming

The radio transmitter and receiver hardware will introduce distortions that are not reciprocal, such as unflatness in the frequency response and unwanted channel coupling. In closed loop, or *advanced*, beamforming **linear** inequalities are taken into account through a process of calibration. This calibration needs to occur if the hardware performance may have changed, e.g. after its temperature has stabilized.

Closed loop beamforming offers the highest performance but also increases the system design complexity. Additional data has to be sent between devices, to create digital encoded correction factors. This implies not only care in the design but more sophisticated interoperability testing. Some of these more advanced modes may become optional parts of the 802.11n standard.

Testing beamforming operation

Test modes have yet to be defined, but the principle of operation will be to feed the receivers of a device under test (DUT) with a variety of channel state information and test the response from the transmitter. This can be achieved using AWG techniques.

4. Radio Block Diagram

Individual hardware and software radio components share a lot in common with a standard OFDM WLAN design. The multiple RF channels may be implemented in discrete transceiver chains with a separate local oscillator, or with integrated transceivers and LO with a separate front end module.

All the impairments that affect a SISO OFDM design, like phase noise and signal compression, will need to be tested in the MIMO radio. In addition, unwanted interaction between the channels needs to be tested. Changes in the level of DSP are an example of the kind of digital-hardware interaction that can cause transients in the analog signals, and which are only apparent when the whole system is working in its normal mode.

Cross coupling between the signals in the channel is an intrinsic part of the channel behavior, but if unwanted coupling occurs between the antennas and the analog to digital conversion, it will degrade the spatial channel performance. In analog RF, it would be like putting an attenuator in the path for of a return loss measurement.

Figure 15 shows the main components in a 2*2 arrangement. In practice, a third receiver or additional transmit chains may be used. The number of spatial streams supported is set by how many independent transmit-receive pairs are used. Any additional hardware is used for increasing the diversity of the channel.

The receiver design is one of the most sophisticated parts of the MIMO radio. Not only must individual channels have the same adjacent channel and interference rejection properties of a SISO radio, they must also be able to separate the spatial streams of the MIMO signal. Accurate channel estimation will be particularly demanding. Design trade-offs will be necessary, which will lead to differences in performance. Integrators will want to isolate these when choosing between vendors. A combination of test signals will be required to do this.

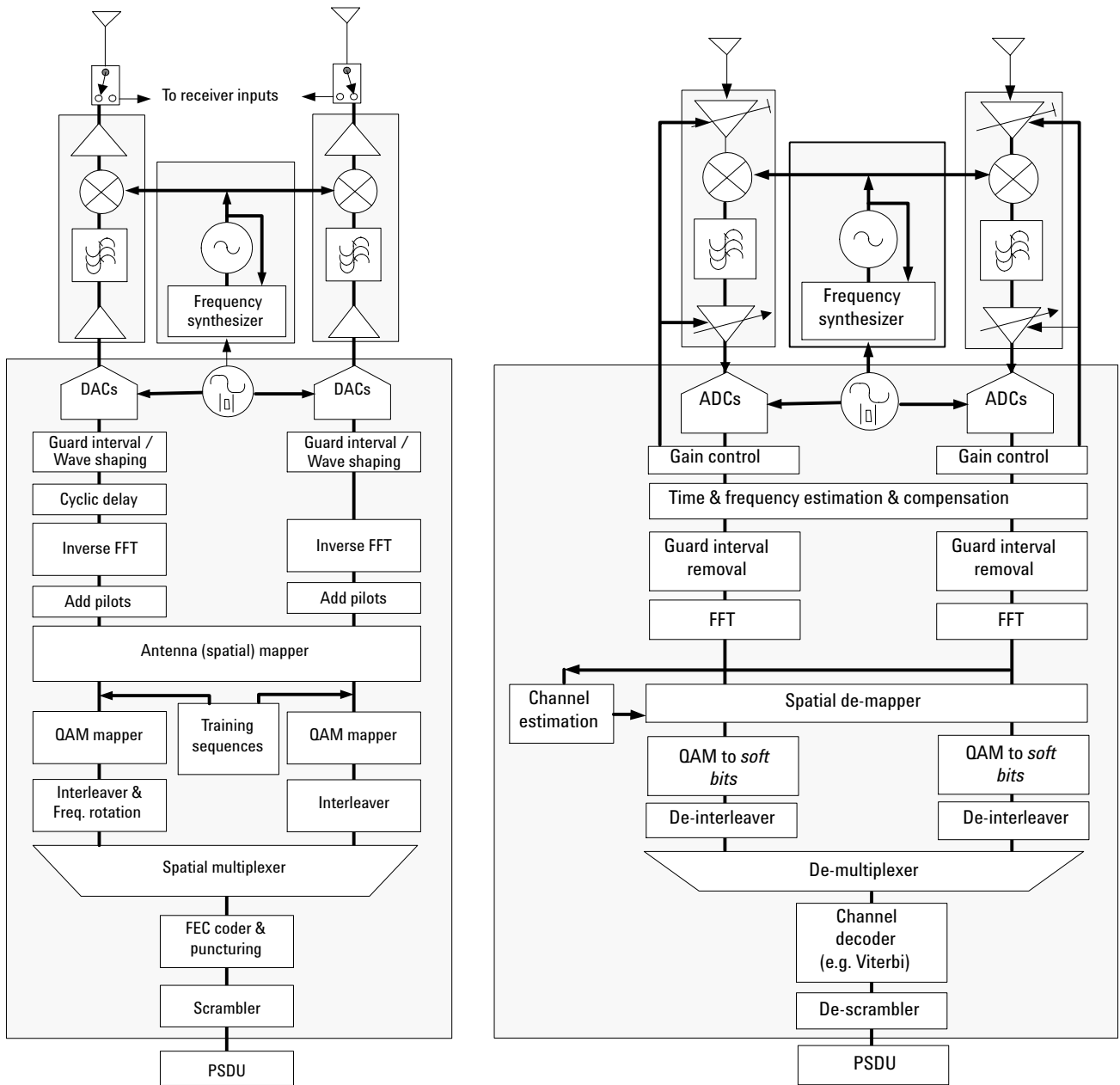

Figure 15. 2*2 MIMO transmitter and receiver block diagrams.

5. Transmitter Testing

Most radio standards evolve to include transmitter quality metrics. The same is expected for 802.11n. At the time of writing, the appropriate measurements are still under discussion. However, there are a number of existing measurement techniques that can be adapted.

5.1. Single channel measurements

Single channel measurements are of interest because they allow the use of existing equipment. For spectrum regulatory testing, they represent the majority of other receivers. For MISO systems, a single channel is all that is required to test the receiver chain. The MISO case includes operation of the multi-channel WLAN transmitter when operating in legacy mode.

Drawbacks of using single input are the inability to fully test the interaction in a device when it is operating in its most demanding mode and switching between test ports, which mean an increase in test time.

5.1.1. Power, power versus time, CCDF

The peak to average power ratio is one of the more demanding characteristics of an OFDM signal, and while the transmit power will be shared between multiple amplifiers, it can be expected there will be a need for each device to draw less supply current.

When measuring power, it is important to remember the power distribution of a WLAN signal varies through the course of the packet. The complementary cumulative distribution function traces in Figure 16 show how the power distribution changes during a legacy packet. It is only a few dB during the preamble, but increases 9 to 10 dB during the payload.

Measurements at the output of an individual MIMO transmitter will look similar to a legacy device (unless spatial channel beamforming is in use). If the signals are combined, such as they will be when they arrive at the receive antenna, the power distribution will be more complex, especially during the preamble. Of particular interest will be the stability of the signal prior and during the MIMO channel estimation period.

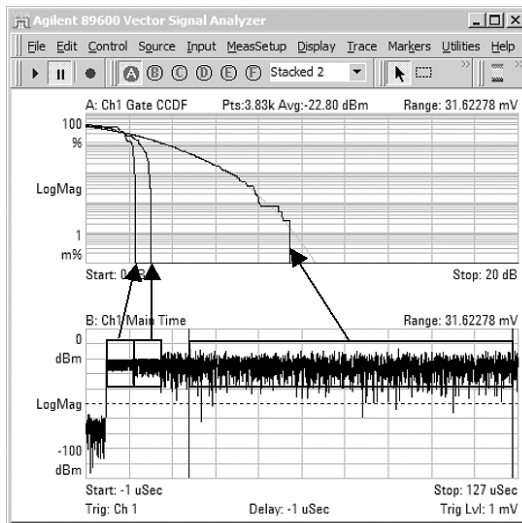

Figure 16. Variations in CCDF during a WLAN packet.

The power ramp for an 802.11a signal has not been clearly defined, but it is important the amplitude has stabilized at the beginning of the preamble. The period prior to the first training symbol is also significant, because zero IF receivers can suffer mis-calibration if they sense a signal immediately before the packet.

5.1.2. Spectrum

To avoid unwanted phased array beamforming effects, small cyclic delays are inserted between transmitters when sending the same signal. When measuring the combined signal with a single channel analyzer, the result is a spectrum plot that either has higher peaks than the equivalent 802.11a signal, or an apparently unflat frequency response. Figure 17 shows an example from a standard swept spectrum analyzer. Note how the prominent short training sequence preamble peaks (circled).

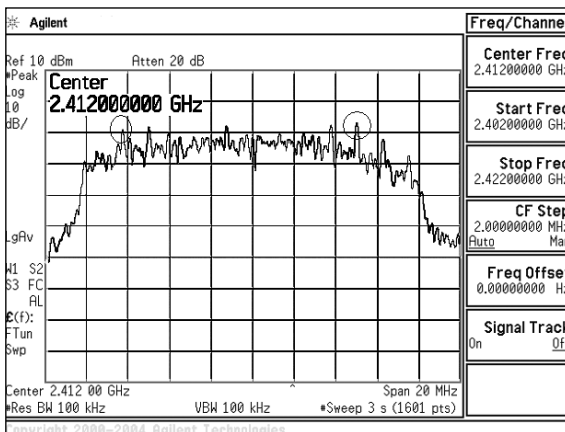

Figure 17. Peaks in power spectrum density measurement accentuated by interaction between antennas.

Except for the highest power devices, this may not be a spectrum regulatory issue, but it will have an impact on the measurement of the spectrum emission mask, because this is done using the highest in-band peak to set the reference level. The effect will be for the mask limit line to be raised.

Time-gated spectrum analysis is a powerful technique for identifying problems during the burst. Figure 18 shows the effect of two transmitter outputs being combined. The bottom trace shows the effect of the combined signals. The position and depth of the dip (circled) in the spectrum is sensitive to the timing offset and the balance between the channels.

Using a suitable test mode, or by measuring the appropriate preamble symbols, it may be possible to apply this principle to make a simple cross channel measurement with a single input analyzer. A 25 ns time delay will cause a 180 degree phase shift across a 20 MHz wide signal, or a repeat interval of 40 MHz for the dip in Figure 18.

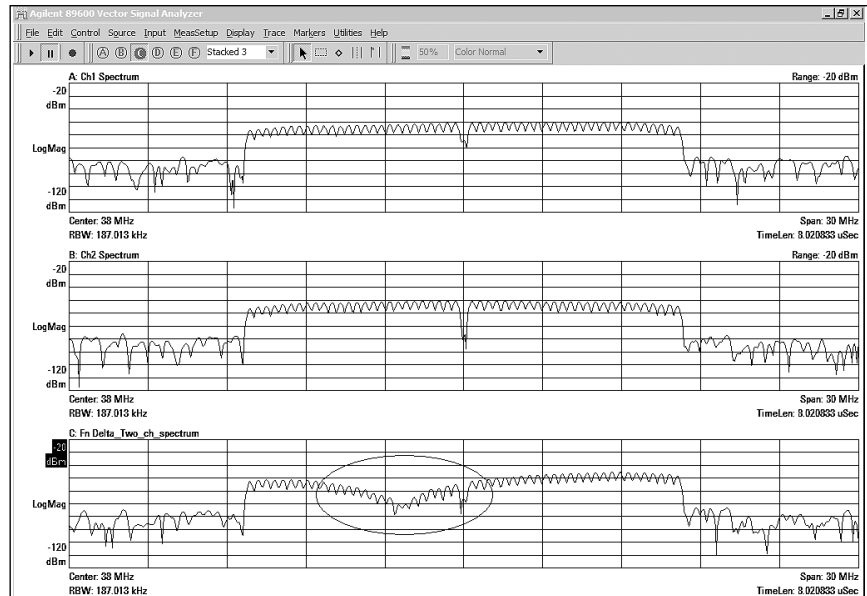

Figure 18. Combining two signals (top and center), which have a small cyclic delay between them gives noticeably unflat frequency response.

Examining the preamble period during the MIMO training symbols of a device with the RF screening removed reveals another simple cross channel test. In Figure 19, the circles show the interleaved sub-carriers leaking across from one channel to another. A Hanning FFT window was used for this measurement to improve the resolution of the frequency response. Given the cyclic nature of the training symbols, this is a good choice.

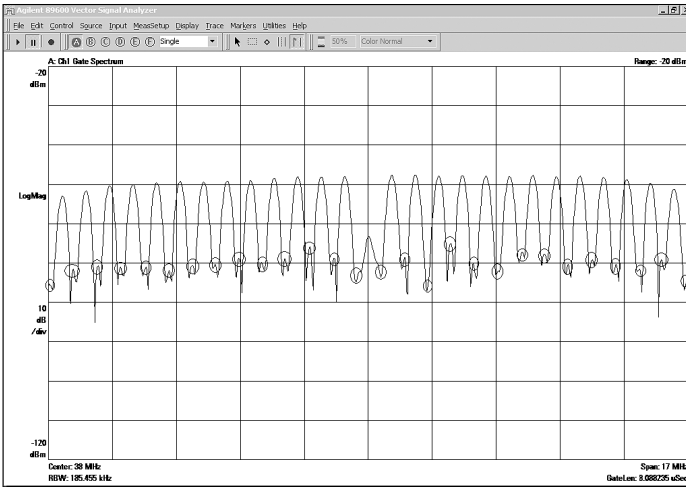

Figure 19. Unwanted cross channel coupling measured during the long training sequence.

5.1.3. Auto-correlation

Auto-correlation allows analysis of repetitive components in a signal, for example in the 800 ns and 3.2 μ s repeat intervals in the 802.11 legacy preamble structure. It may also be used to check for cross coupling. The signals in Figure 20 are the same interleaved multi-tones used for the measurement in Figure 6. The ratio of the peaks in the auto-correlation measurement indicate the overall cross coupling between the channels. The complex coefficients of these results (displayed by toggling the scale – see inset) provide information about the phase relationship between the signals.

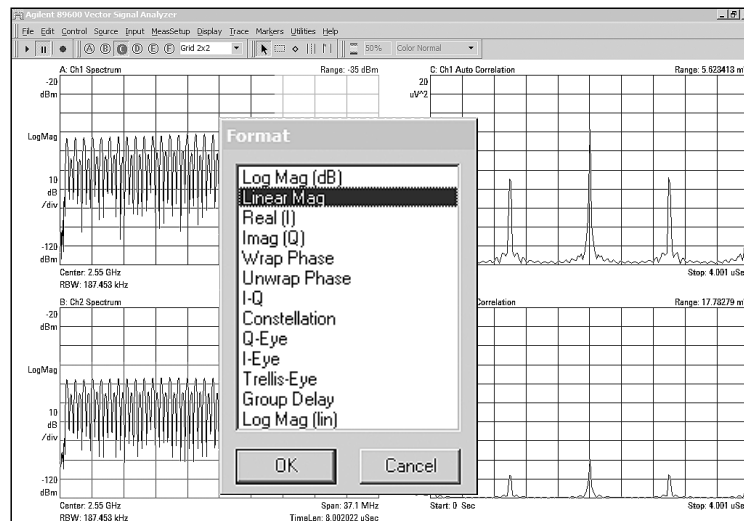

Figure 20. Auto-correlation measurement of the frequency interleaved signal used in the example of Figure 6. The relative sizes of the peaks are related to the strength of the channel coupling.

5.1.4. Frequency & phase settling, EVM

Using the 89600 VSA software, the normal 802.11a EVM measurement can be taken if the preamble structure is correct. The signal needs to have a duration of at least 28 us, but it does not have to be a standard packet. This means the phase, frequency and amplitude settling and EVM can be measured on legacy compatible packets. Use <Preset to Standard> <802.11a/g> and set <Max Result Length> to 1 to do this.

Note: It has been found that some devices require the use of channel estimation sequence instead of the short training sequence. Depending on the cause, this may have an impact on interoperability with other radios.

On occasions, it may be necessary to demodulate a signal with a change in the amplitude during the preamble. As shown in Figure 21, this can be done by ensuring <Amplitude Tracking> is checked.

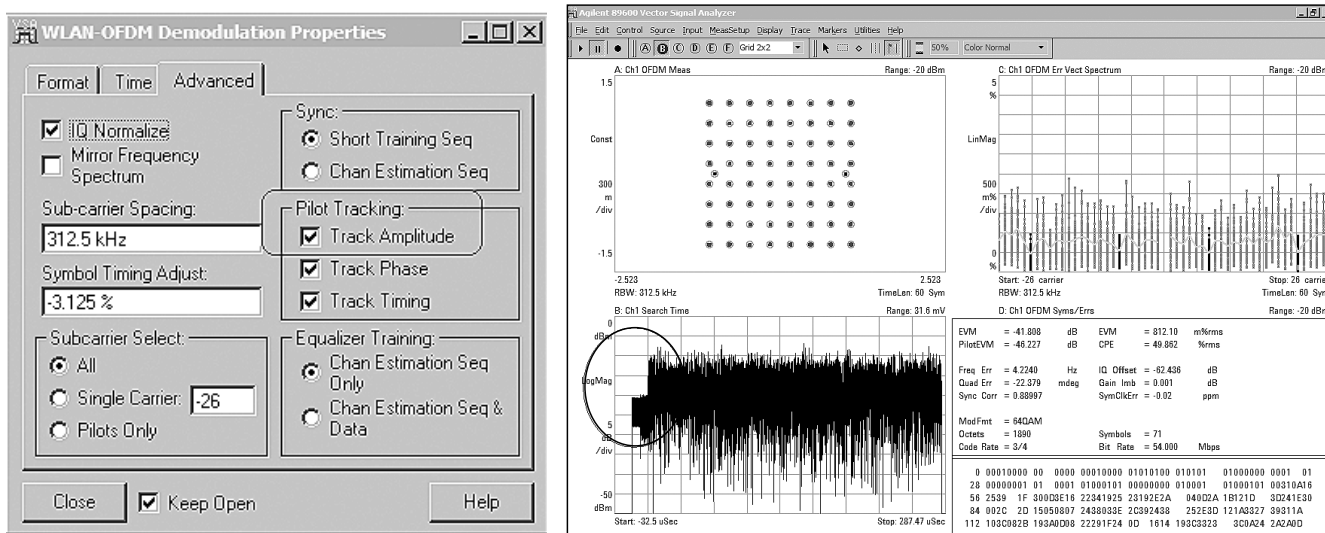
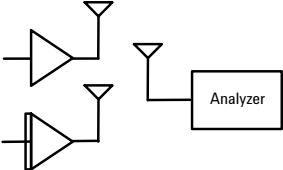
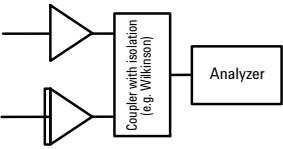
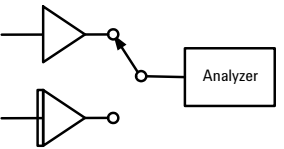

Figure 21. Use of amplitude tracking in the 89600 VSA software to demodulate a signal with a 6 dB jump in amplitude during the preamble (circled).

Table 2. Measurement possibilities using a single input signal tester

Configuration	Antenna	Combined	Switched
Measurement			
EIRP	Yes, with spectrum analyzer	No	Estimate by adjusting for antenna factors
Spectrum mask	Yes. Shows effects of antenna coupling in RF output stages, but difficult to isolate failures problems	Yes. May need to isolate channels before combining if the RF stages are susceptible to inter-modulation	Yes. May not show cross coupling distortion effects
Channel frequency response	Not using the normal single channel measurement, because time delays between the channels cause signal cancellations and additions at different frequencies		Yes
Frequency error	Yes. Noise floor may affect EVM reading	Yes	Yes
SISO error vector magnitude	Single channel results can be affected by time delays between channels, causing worsening of the EVM result on some sub-carriers, depending on depth of cancellation		Single channel & STBC
Power, power versus time	Uncertainty depends on antenna coupling factors. Precise level also depends on the delays between the channels	Reading may be affected by delay between the channels, causing signal addition or subtraction	Yes
CCDF (power distribution)	May not be useful, unless the tester is used to emulate an individual input of a receiver		Yes
Unwanted coupling (in preamble)	Yes	Yes	Yes
Cyclic delay check	Yes	Yes	No
STBC demodulation	Yes	Yes	Requires a repeating waveform to allow multiple captures, and software to combine the signals. The result may have more noise due to timing jitter and phase variations between captures.
SDM demodulation	No	No	

5.2. Two channel measurements

Two channel measurements allow more complete analysis of the MIMO radio. Cross channel measurements verify the frequency & timing relationship between signals, and can show how errors specific to individual channels combine to degrade the spatial channel performance of the transmitter and receiver.

The needs for timing alignment and a shared local oscillator are similar to those discussed in section 6.2.1 for signal generation. Measuring the RF phase relationship through individual components will be easiest with a shared local oscillator. It will require calibration of the phase at the test connection points, with the type of techniques used for vector network analysis. Considerable care will be needed with RF matching to ensure repeatable measurements. In contrast, measurements on complete transmitters may be less demanding when testing in manufacturing.

There are three options for making multi-channel transmitter measurements, summarized in Table 3.

Table 3. Summary of multi-channel measurement hardware options

Instrument	Features
Modular system, e.g. 89641A vector signal analyzer VXI hardware and software	<ul style="list-style-type: none">• High Performance signal capture• Longest capture length• RF & baseband inputs• Two channels fully supported with 89600 VSA• Expandable with custom software
Multi-input instrument Oscilloscope, e.g. 54853A Infiniium oscilloscope	<ul style="list-style-type: none">• Up to four channels• Two channels fully supported with 89600 VSA• Direct RF or baseband input• Most economical
Separate instruments, e.g. E4440A PSA Series spectrum analyzer	<ul style="list-style-type: none">• Most flexible use of individual items of equipment• Highest performance signal capture• Some restrictions on measurement timing alignment• Custom software required

5.2.1. Using an oscilloscope as a digitizer

The 8-bit resolution of the oscilloscope digitizer does not directly relate to the residual errors in measurements like EVM. If the signal is over-sampled, the effective number of bits is increased and the instrument noise floor is the main limitation.

The oscilloscope is obviously very flexible in terms of the type of signal it can analyze. If the signal is RF, the high performance oscilloscopes can even measure them directly, although any spurious signals may be aliased into the measurement. The sample rate and memory depth determine the length of time capture available. There is a step change in the memory available at 2 or 4 GSa/s (model dependent), and measurement speed increases as the number of points is reduced.

Table 4. 802.11a EVM sample measurement results for the 54850 Series oscilloscope, using an E4438C as a source

50 to 100 MHz	2.4 GHz	5.2 GHz
0.8% [4 GSa/s]	1.3% [2 GSa/s]	1.5% [5 GSa/s]
1% [1 GSa/s]		2.2% [2 GSa/s]

Being able to use direct RF inputs in the 54850 Series oscilloscope is convenient, because it simplifies the hardware configuration. If higher performance is required, frequency down-conversion can be used.

***Note:** The sample rate using four channels remains constant with the 54850 Series. It is reduced when using the 54832.*

5.2.2. Coherence

Coherence is a two channel measurement that indicates the similarity between two signals. In transfer functions, it indicates how much of the output power is coherent with the input power. In other words, coherence is a measure of the power in the output signal caused by the input.

The plot in Figure 22 shows how this measurement can be used to easily show different points in a two channel WLAN signal. This kind of display is most useful for pattern recognition as part of basic interoperability testing. The bottom two spectrograms were measured directly at the transmitter outputs, and are similar to a Greenfield 802.11n burst.

The coherence measurement requires at least two averages to work; four were used for the result in Figure 22. To make this measurement a time record of the signal is captured, and the coherence measurement is made on the captured data.

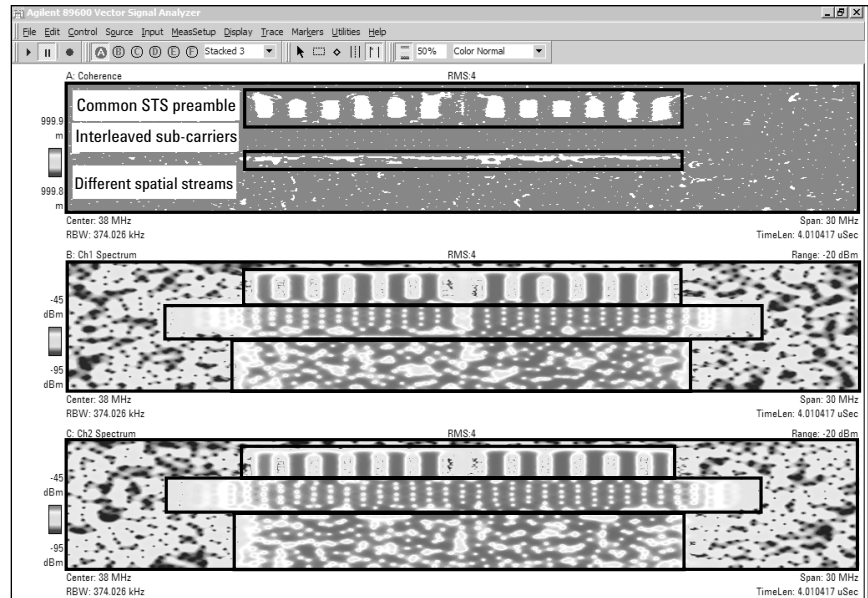
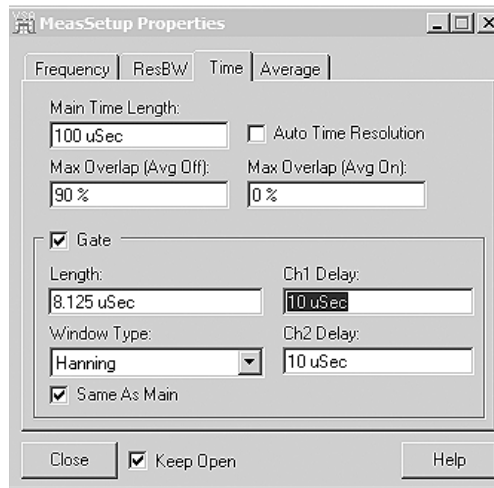
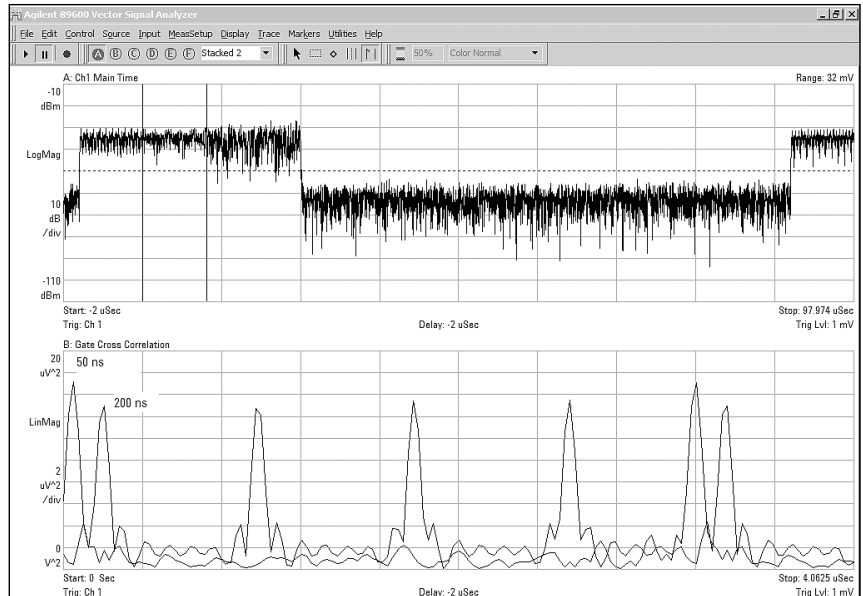

Figure 22. Coherence spectrogram, showing how signal coherence changes during the first stages of a MIMO WLAN burst. Four running averages used, with a 98% overlap.

5.2.3. Cross correlation

The need for delays between the channels, and the effect on parts of the spectrum response was described earlier. A measurement of the delay is possible automatically using the cross channel correlation measurement. An example of two signals with a 200 ns delay is shown in Figure 22.

The width of the peak in the correlation measurement is inversely proportional to the bandwidth of the signal. Broadband noise produces a very narrow peak. A 17 MHz wide OFDM signal gives a time resolution of approximately 25 ns.



Notes: Negative delays are not shown. The leading signal should be applied to Channel 1.

A spectrogram of correlation versus time can be useful to confirm that the correct timing relationship is maintained through the packet.

Figure 23. Cross channel correlation measurement and setup, showing a 200 ns time delay changing to 50 ns during the training sequences in a Greenfield style packet.

5.2.4. Other two channel measurements

A cross channel frequency response measurement gives a simple cross coupling check during the MIMO channel estimation phase of the preamble. A time-gated measurement with a Hanning window is used. The gating is adjusted to fit precisely around the LTS symbols. In Figure 23, by centering the display at 0 dB, we can measure the cross coupling on both channels. Channel 1 is the reference for both, so Ch2 > Ch1 coupling is shown, inverted, at the top of the plot. Ch1 -> Ch2 coupling is shown at the bottom.

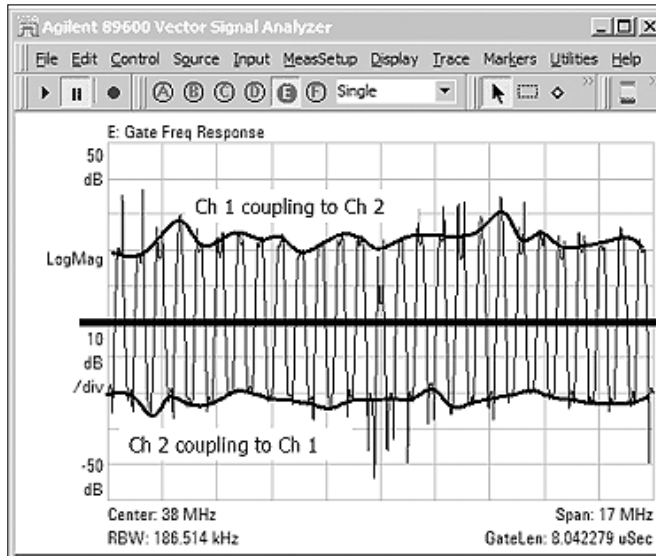

Figure 24. Simultaneously measuring cross channel coupling using the long training sequence.

5.3. Going beyond two channels

Both the oscilloscope and VXI hardware can be used to capture four inputs. Depending on the test being carried out, the lowest cost way of increasing the number of measurement channels may be to switch between channels. Figure 24 shows an example of the standard matrix configuration available.

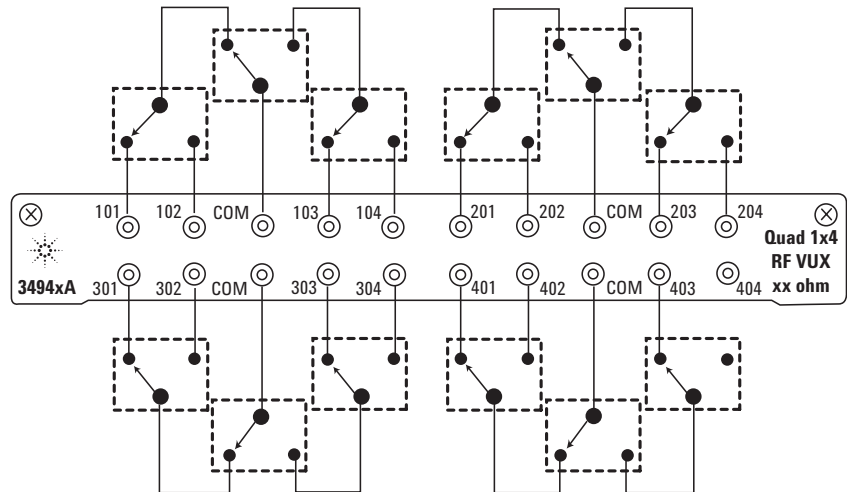

Figure 25. 34941A quad 1*4 50 ohm 3 GHz multiplexer.

6. Receiver Testing

The MIMO receiver deals with two key sections in the burst, channel estimation and multi-channel data separation. During the receiver design, these parts of the burst can be individually identified both at RF and (Z) IF using the equipment described for transmitter testing. Figure 26 shows the variety in test configuration interface points. The 89600 VSA can be used with logic analyzers as well as analog capture hardware.

The operation of a receiver test depends on the application software controlling the DUT. Generally parametric testing is carried out using test modes. These are more efficient than running through the normal association and data transfer processes.

In a single channel test, RF level is the main control parameter. The key metric is sensitivity, which is the RF level required for a specified packet error rate at a given modulation rate. Adjacent channels, noise and other interference are added for a more comprehensive testing.

With multi-channel radios, receiver testing will start with the same single channel tests, with the signal source being switched to each receiver input in turn. When it progresses to MIMO operation, a test channel has to be defined for the result to make any sense. This sets the coupling factors between the channels, and as shown in Section 1, these are fundamental in determining the capacity of the channel.

There are numerous test channels that need to be validated in the RF-DSP design. Even the MATLAB® program defined for the 802.11n task group provides only a subset.

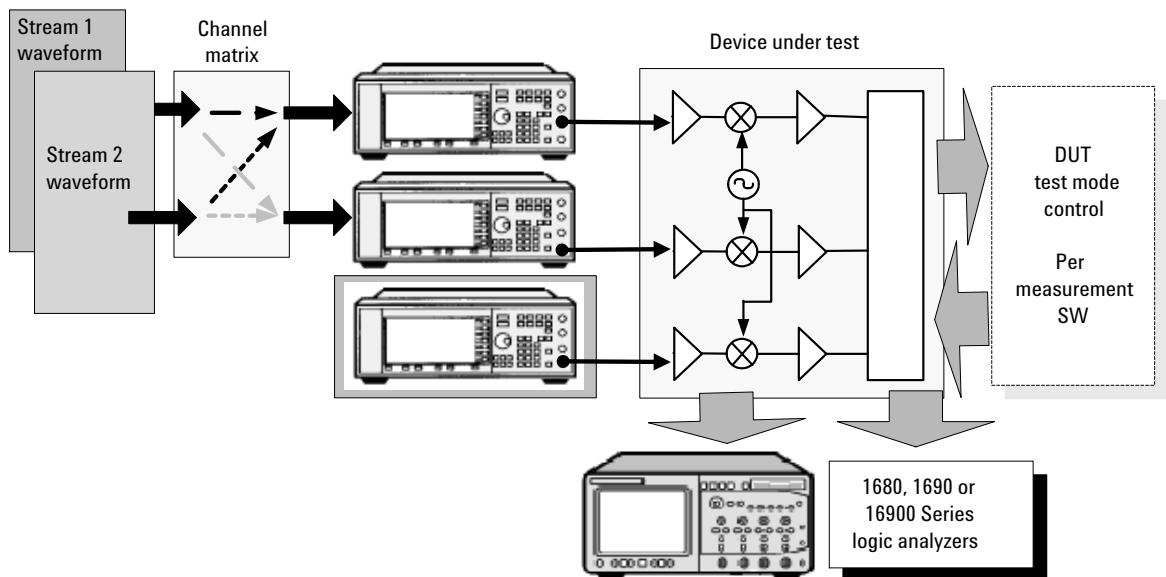

Figure 26. Overall receiver test configuration. Analog performance in the down-conversion path can be tested with oscilloscope or VXI hardware. System test requires vendor specific software. For the radio designer, this will give access to detailed performance information & control.

The most flexible and widely available technique for creating the test signals needed is through the use of arbitrary waveform generation, using simulation tools such as Agilent's ADS software and MATLAB. Several free utilities are available for transferring these waveform files into Agilent signal generators, including a MATLAB download assistant application and the N7662A Signal Studio Toolkit software. These can be downloaded from www.agilent.com/find/esg.

6.1. Single source

There are several ways a single source can be used to simultaneously test multiple inputs, using RF signal splitters. The advantages are that it's fast and doesn't require extra hardware. But the applicability depends on the operation of the baseband circuit, which will be determined by the chip vendor. This approach cannot test the radio for increases in capacity from the use of spatial division multiplexing

6.1.1. Sensitivity improvement over SISO radio

If a standard, single channel OFDM signal is fed first to an individual receiver input, then all of the radio input sensitivity levels should be simultaneously increased by a factor dependent on the number of independent receiver paths. The actual improvement will depend on the hardware configuration and the method used for signal combining after the inputs are digitized. Where supported, the designer will have specifications for the improvement expected, based on theoretical calculations and their own device measurements.

6.1.2. The keyhole method

A second technique, known as the *keyhole* method¹, can be used to test the MIMO channel recovery process. It requires a special test mode operation for the DUT. If we consider the use of the interleaved multi-tones for channel estimation, we can design a test signal that has equal levels for as many transmitters as the system should have. If this signal is presented to all the receiver inputs, the radio will calculate the channel coefficients. It should find there is no increase in channel capacity over the SISO case. In making this calculation, the normalized channel coefficients should be found to be 1 or 0. By reporting deviations from 1 and 0, which occur due to imperfections in the radio hardware or noise at the receiver inputs, it will be possible to judge how well the radio is performing.

6.2. Multiple source

When considering the use of multiple sources using standalone instruments, it is important to understand the needs for timing alignment of the baseband signals and whether a common local oscillator is required. These needs can be satisfied with the E4438C options (details in Appendix A), but may result in a less flexible equipment arrangement. For example, maintaining separate local oscillators (LOs) means adjacent channel testing is possible as well as MIMO testing.

1. *Prototype Experience for MIMO BLAST Over Third Generation Wireless System IEEE Journal on Selected Areas of Communications*, Vol 21, No. 3 April 2003.

6.2.1. Requirement for independent or common local oscillator

A common local oscillator removes two potential sources of error in receiver testing. The first issue is changes in the static phase offset between channels each time the frequency is changed. For most test cases, the DUT receiver software will remove this error. For traditional phased array testing, phase drift over time would need to be accounted for.

The second issue is the additional phase noise introduced by uncorrelated noise sources in the separate oscillators. To investigate this effect, a measurement was carried out where the RF signals from two E4438C signal generators were mixed together. The first carried a standard 802.11a OFDM signal. The second was a continuous wave (CW) signal. The EVM was measured directly from the modulated signal generator, and then the EVM of the frequency down-converted signal was measured. The down-converted signal contains phase noise contributions from both signal generators.

There was less than 0.1% difference in the EVM reading (of 0.6%). The conclusion is the phase noise from the E4438C is not a significant factor in an EVM measurement at this level. In the most demanding applications, or if the generator phase noise is higher than the E4438C, a common local oscillator may still be appropriate.

6.2.2. Phase synchronous RF signal generation

There are two options for baseband signal generation, using either a standalone AWG, like the Agilent N6030A arbitrary waveform generator or an AWG built into an RF signal generator like the Agilent E4438C analog signal generator, or the Agilent E8267D/E8257D PSG signal generator.

If the 10 MHz references are common between the sources, the phase between the RF signals can be precisely adjusted, using the signal source functions <Frequency> <Adjust Phase>. This setting is lost if the frequency is changed. The coherent outputs on the rear panel of the E4438C can be used with external phase detection to calibrate the RF phase of the signal at a defined reference point for each signal.

If matching cable lengths are used, it is likely the channel-to-channel timing alignment will be good without additional adjustment. It may be still be useful to introduce deliberate timing offsets, to test the effect on the receiver. <IQ Skew> adjusts the time delay between the channels in the AWG, and therefore accommodates this impairment (up to a maximum of 5 ns).

6.2.3. Using an offset IF to create two signals from one AWG

One arbitrary waveform generator, can be used with the E4438C or E8267D signal generators to generate two MIMO channels.

The high performance of the arbitrary waveform generator and the flexible modulation path switching in the E4438C signal generator allow the I and Q channels to be used to create two independent channels, with an IF frequency in the 20 to 25 MHz range.

This requires the waveform file to be created with this frequency offset. When the I and Q signals are used to drive external 90 degree phase splitters, adjacent channel rejection of 25 to 30 dB is achieved, with a residual EVM of a double-clocked 802.11a signal measuring approximately 1% at 2.4 GHz. See Figure 29.

The signal quality is lower than when using the normal DC based I/Q signal generation technique, but excellent timing alignment is guaranteed. The quadrature skew adjustment in the signal generator can be used to improve the adjacent channel rejection beyond the basic performance of the 90 degree splitters.

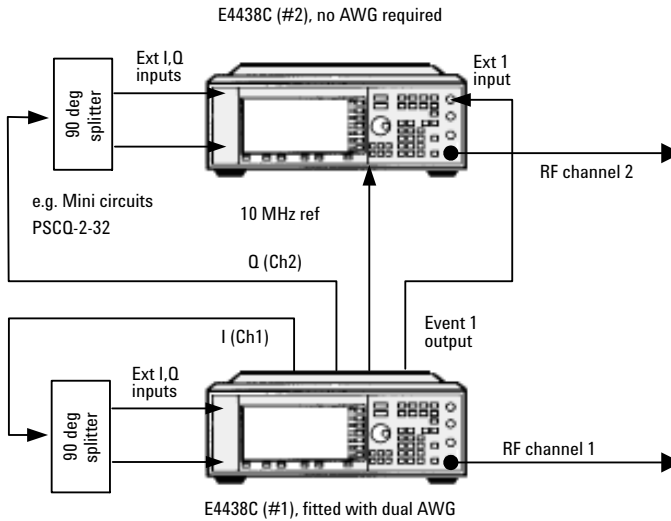

Figure 27. Using the dual arbitrary waveform generator in one E4438C to create the IF signals for two independent, precisely aligned channel waveforms.

The front panel configuration of the E4438C signal generator is shown in Figure 28. The frequency setting is independent of the configuration of the AWG.

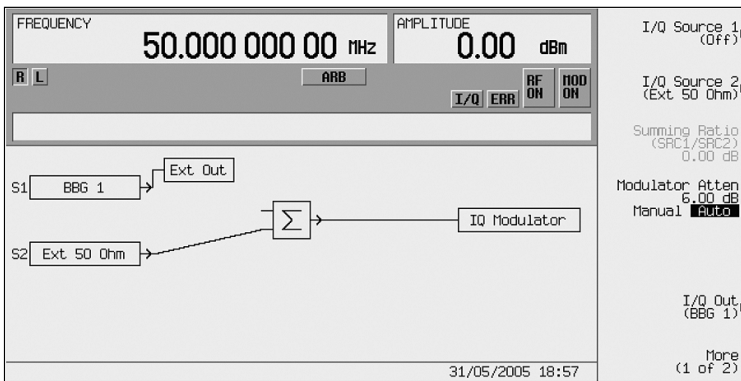

Figure 28. Modulation path switching in the E4438C.

The performance achieved using this method is shown in Figure 29. The adjacent channel performance would appear to make it suitable for testing any standard receiver, since the 802.11 specifications ensure a device can operate with other transmitters nearby.

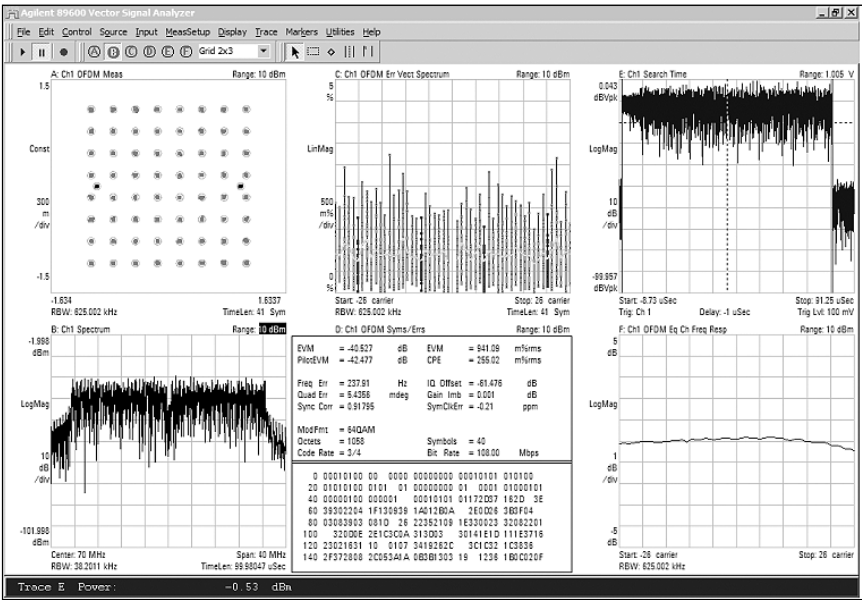
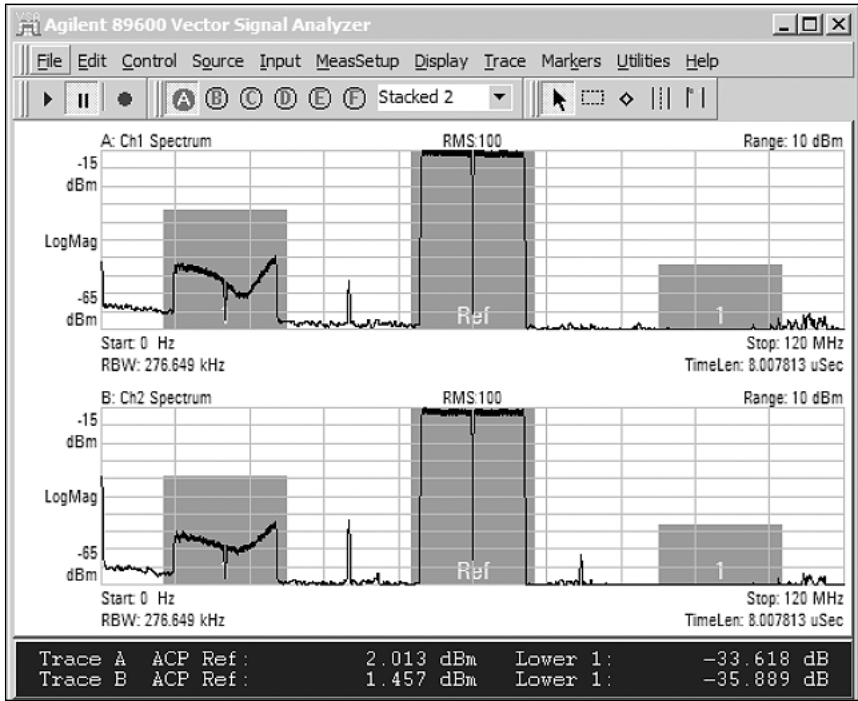

Figure 29. Example of adjacent channel rejection (802.11a signal) and EVM performance (double-clocked 802.11a) of dual channel signal generated from a single AWG.

6.2.4. RF amplitude correction in the E4438C

The automatic level control of the second signal generator can be gated over only the active part of the burst. This ensures the output level is consistent with the front panel setting. As shown in Figure 27, the Event 1 output of the signal generator with the AWG is fed to <Ext 1 Input>. The right screen in Figure 28 shows the type of display used to set the Event 1 marker position.

The following settings are used:

<Amplitude> ALC <on> <100Hz>

<Mode> <Dual Arb> <Arb Set Up> <Marker Utilities> <Set Markers> <Set Marker on Range Of Points>

Example:

<Marker> 1, <First Mkr Point> 1, < Last Mkr Point> 8994 Key down to highlight the waveform you want to address:

<Apply to Waveform>, <Display Markers>

<Marker Routing>, <Pulse/RF Blanking>, <Marker 1>

The RF level on the E4438C with the AWG should now be corrected. The marker is fed to Event 1 on the rear panel, which may be used to feed Ext 1 input on the second generator.

On the second E4438C:

Select <Pulse>, <On>, <Pulse Source> Ext1 DC coupled. The RF blanking waveform is generated from the Event 1 Out when Marker 1 is active.

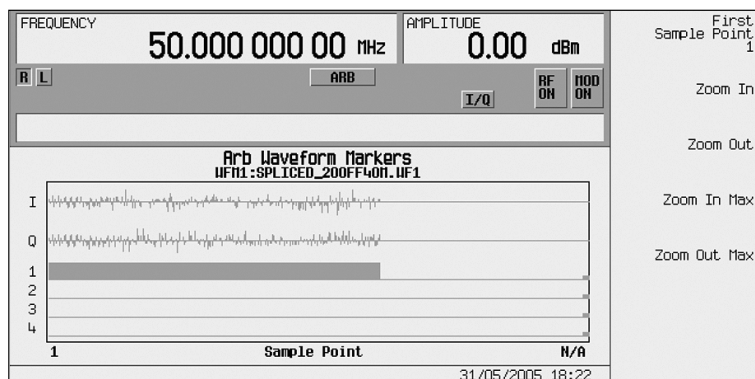

Figure 30. Use of marker functions and ALC blanking for amplitude control in the E4438C.

6.2.5. Other receiver testing

The full suite of SISO radio testing will need to be performed. Refer to the other application notes listed in Appendix B.

Appendix A.

Agilent Solutions for Multi-Channel Signal Generation and Analysis

Signal Generation

(Real time) frequency up conversion

	Multi-channel support	RF bandwidth	Maximum frequency	EVM
E8257D/E8267D PSG signal generator	<ul style="list-style-type: none"> • 10 MHz reference input/output • Baseband reference input • (Arbitrary waveform generator) trigger input 	80 MHz internal 160 MHz (external) Option 015: 2 GHz (external)	44 GHz	< 1% EVM at 5 GHz
E4438C analog signal generator	If a shared local oscillator is required (available for up to eight signal generators), each source requires these options to provide external access to the LO paths: <ul style="list-style-type: none"> • 250 MHz to 4 GHz special Option HCC (E4438C) • 4 to 6 GHz special Option HBC (E4438C) • 250 MHz to 3.2 GHz, 3.2 GHz to 10 GHz special Option HCC (PSG) In addition, the Z5623A Distribution Amplifier is required For an external baseband clock input: Special Option HEC (for each E4438C); HEC comes standard on the PSG A separate 200 to 400 MHz CW source is needed to serve as the common baseband clock.	80 MHz (internal) 160 MHz (external)	6 GHz	< 1% at 5 GHz

(External) arbitrary waveform generation

	Multi-channel support	Bandwidth	Resolution	Performance indicator
N6030A arbitrary waveform generator	<ul style="list-style-type: none"> • Native two channels • 16 channels using sync clock • Multiple trigger options 	500 MHz both channels	15 bits	< 0.5%
N6031A arbitrary waveform generator			10 bits	< 1%

Signal Analysis

(Real time) frequency down conversion

	Multi-channel support	RF bandwidth	Maximum frequency	EVM
E4440A PSA Series spectrum analyzer	10 MHz reference lock External digitizer trigger input (1.5 ns)	Option 140 40 MHz (internal bandwidth) or Option 122 (internal bandwidth) Option 123 Switchable MW preselector bypass	26.5 GHz	< 1% Requires Option 123 Switchable MW preselector bypass (for measurements above 3 GHz)
89640 vector signal analyzer	2 channels	37.1 MHz	2.7 GHz	< 1%
89641 vector signal analyzer	2 channels	37.1 MHz	6 GHz	< 1%
54855A Infiniium oscilloscope	4 channels	> 1 GHz	6 GHz	See Table 4
DS08000 Series ultra-high performance Infiniium oscilloscope	4 channels	> 1 GHz	13 GHz	

Digitizers

	Multi-channel support	Bandwidth	Resolution	EVM
54830 Series digital storage oscilloscope	<ul style="list-style-type: none"> • Native 2 or 4 channels • Common sampling clock • Common trigger • 4 GSa/s for 2 channels; up to 128 Mpts capture 	Up to 1 GHz, dependent on model	8 bits, but the effective resolution increased by over-sampling	See Table 4
54850 Series high bandwidth oscilloscopes	<ul style="list-style-type: none"> • 20 GSa/s on all 4 channels simultaneously • 1 Mpts capture at full rate • 32 Mpts capture at 2 GSa/s 	Up to 6 GHz 13 GHz using DS08000 Series		
89610 vector signal analyzer (VSA)	Up to 8 channels Shared clock Shared trigger	39 MHz	14 bits	< 1%

Test Equipment with Multi-Channel Capability

Vector signal analyzers, 89600 Series vector signal analysis software

- Versatile and precise signal analysis
- 37.1 MHz RF capture bandwidth
- Provides in-depth analysis of IEEE 802.11 transmitter and receiver chains
- Automatic detection and demodulation of 802.11a/b/g formats
- Provides modulation quality analysis for IEEE 802.11a OFDM signals, including EVM versus time and EVM versus sub-carrier
- 89600 vector signal analysis software can be used with a variety of digitizers including: PSA and ESA-E spectrum analyzers, N4010A wireless connectivity test set, oscilloscopes, logic analyzers and VXI hardware

89645A: dc to 6 GHz tuner

Recommended 89600 Series options (or 802.11a)

- Option AYA/B7R vector signal analysis and OFDM demodulation
- Option 105 dynamic links to EESof/Advanced Design System

Signal generator, E4438C ESG vector signal generator

- Generate IEEE 802.11 signals for transmitter & component tests
- Send formatted packets for receiver PER testing
- Generate baseband signals for direct input to MAC or analog circuits

Recommended E4438C Options (for 802.11a)

- Option 417 IEEE 802.11a/b/g
- Option 506 6 GHz operation
- Option UNJ Enhanced phase noise
- Option 601 or 602 Internal baseband generator with 8 or 64 Msa of waveform memory
- Option 005 6 GB hard-drive

Related products

- E4438C Option HEC - External baseband clock input is useful for repeatable triggering of multiple baseband generators used in phase coherent applications. Requires an external 200 to 400 MHz CW source to serve as the common baseband clock.
- E4438C Option HCC - Generate phase coherent carriers from 250 MHz to 4 GHz with up to eight sources when used with a Z5623A distribution amplifier.
- E4438C Option HBC - Generate phase coherent carriers from 250 MHz to 6 GHz with up to eight sources when used with option HCC, and a Z5623A distribution amplifier.

Oscilloscopes, 54830 Series

- Up to 1 GHz operation

Performance oscilloscopes, 54850 Series

- Up to 6 GHz direct RF input, 4 channels

Network analyzers, ENA Series

- Provides measurement of antenna VSWR, and performance of PA, LNA and RF switch

Accessories

Oscilloscope probe, 54006A

- Passive probes with very low capacitance (0.25 pF)

Infiniimax differential probe system, 54006A

- RF bandwidth to 7 GHz

E2904N IO libraries suite

- Software to simplify the configuration of remotely controlled instrument

RF Switching

Switching mainframe, 34980A

- Up to 8 plug-in modules

Switch matrix, quad 1*4 3 GHz RF switch, 34941A

- Plug-in module for 34980A
- 50 ohm unterminated
- SMA connectors

Microwave switches, 34946A/47A

- Dual / triple SPDT 50 ohm terminated
- Operation to 20 GHz

Appendix B. Recommended Reading

IEEE Journal on Selected Areas in Communications: *From Theory to Practice: An Overview of MIMO Space Time Coded Wireless Systems*. April 2003. (Volume 21 No. 3)

Agilent IEEE 802.11 Wireless LAN PHY Layer (RF) Operation and Measurement, Application Note 1380-2, literature number 5988-5411EN

Agilent Equalization Techniques and OFDM Troubleshooting for Wireless LANS, Application Note 1455, literature number 5988-9440EN

Agilent WLAN Baseband and RF Transmitter Analysis Using Agilent Infiniium Oscilloscopes and 89600 Software, Application Note 1486, literature number 5989-0327EN

Useful Web Links:

Agilent WLAN Application & Product information:
<http://www.agilent.com/find/mimo/>

IEEE 802.11 Home page:
<http://www.ieee802.org/11/>

Demo Software

89600 vector signal analysis software demonstration software available on CD, or download (250 MB) at: www.agilent.com/find/89600

Partial Derivation of Expression for Singular Values

The mathematical starting point for the channel capacity is:

$$C = B \cdot \log_2 \left[\det \left(\mathbf{I} + \frac{\rho}{N} \mathbf{H} \mathbf{H}^H \right) \right],$$

where ρ is the SNR and where \mathbf{H} is the matrix representing the channel coefficients, and \mathbf{H}^H is the Hermitian (conjugate transpose)

It can be shown that this can be rewritten as:

$$C = \sum_i B \cdot \log_2 \left(1 + \frac{\rho}{N} \lambda_i \right) \text{ with } \lambda_i \text{ the eigenvalues of } \mathbf{H} \mathbf{H}^H,$$

Now, because $\sigma_i(\mathbf{A}) = \sqrt{\lambda_i(\mathbf{A} \mathbf{A}^H)}$

The original expression can also be written as

$$C = \sum_i B \cdot \log_2 \left(1 + \frac{\rho}{N} \sigma_i^2(\mathbf{H}) \right)$$

Appendix C. Glossary

- Alamouti Coding:** A space time coding technique involving symbol reversal.
- Beacon:** A regular RF transmission used by stations to discover if there are other devices within its operating range. Beacons are also used for coarse timing alignment.
- Beamforming:** A mechanism to associate signal power with a single physical location.
- Blind source separation:** A MIMO technique that does not require explicit channel training information.
- Channel State Information (CSI):** A description of the RF characteristics of the path from transmitter to receiver
- Code puncturing:** An insertion of redundant data bits to increase the robustness of forward error correction.
- Coherence:** A measure of the spectral similarity of two signals.
- Cyclic delay diversity:** A delay between transmitted signals to avoid unwanted phased array beamforming.
- Cyclic prefix:** A copy of the end of a symbol, transmitted at the start of the symbol.
- Goodput:** The number of bits available to the application layer at the receiver, divided by a specified time interval.
- K factor:** The (Ricean) K factor indicates the ratio of direct and scattered signals from the channel.
- Legacy (device):** An 802.11a, b or g device.
- Maximum ratio combining:** Vector addition of signals.
- Medium Access Control (MAC):** The function of the software that adapts wired LAN transmissions, so they are suitable for sending over a RF link.
- Rank:** The number of independent equations in a matrix.
- Spoofing:** Use of the Legacy RATE and LENGTH fields to prevent a Legacy device from transmitting for a defined period of time.
- Successive interference cancellation:** A receiver technique for separating combined signals.
- Water-filling:** A technique for allocating power to the spatial streams in SCB.
- Zero forcing:** The simplest form of channel removal; generally of little use in a practical receiver due to the effects of noise.

Appendix D. Symbols and Acronyms

ACK	Acknowledgement
ADS	Advanced Design System
AP	Access Point
BER	Bit Error Rate
AWG	Arbitrary Waveform Generator
BLAST	Bell Labs Space Time Architecture
bps	bits per second
BPSK	Binary Phase Shift Keying
BSS	Blind Source Separation
CCA	Clear Channel Assessment
CCDF	Complementary Cumulative Distribution Function
CDD	Cyclic Delay diversity
CRC	Cyclic Redundancy Check
CSMA/CA	Carrier Sense Multiple Access with Collision Avoidance
CSI	Channel State Information
DUT	Device Under Test
EIRP	Equivalent Isotropic Radiated Power
ESG	[Electronic] Signal Generator
ETSI	European Technical Standards Institute
EVM	Error Vector Magnitude
IF	Intermediate Frequency
IFS	Inter Frame Spacing
ISM	Industrial, Scientific and Medical
LO	Local Oscillator
MAC	Medium Access Control
ML	Maximum Likelihood
MMSE	Minimum Mean Squared Error
MRC	Maximum Ratio Combining
NIC	Network Interface Card
OFDM	Orthogonal Frequency Division Multiplexing
PDU	Protocol Data Unit
PER	Packet Error Rate
PHY	Physical [layer]
PLCP	Physical Layer Convergence Protocol
PMD	Physical Medium Dependent
PN9, 15	Pseudo Random Number
PSDU	PLCP Service Data Unit
QAM	Quadrature Amplitude Modulation
RBW	Resolution Bandwidth
RX	Receiver
SCB	Spatial Channel Beamforming
SDM	Spatial Division Multiplexing
SDMA	Spatial Division Multiple Access
SIC	Successive interference Cancellation
STBC	Space Time Block Coding
SVD	Singular Value Decomposition
TDD	Time Division Duplex
TPC	Transmit Power Control
TX	Transmitter
UNII	Unlicensed National Information Infrastructure
VBW	Video Bandwidth
VCO	Voltage Controlled Oscillator
VSA	Vector Signal Analyzer
ZF	Zero Forcing

Appendix E. References

1. *TGn channel Models IEEE 802.11-03/940r4*
2. *TGn Sync Proposal Technical Specification IEEE 802.11-04/0889r7*
3. *WWiSE Proposal: High Throughput Extension to 802.11 standard IEEE 802.11-05/0149r5*
4. *IEEE TGn Comparison Criteria IEEE 802.11-03/814r31*
5. *Prototype Experience for MIMO BLAST Over Third Generation Wireless System IEEE Journal on Selected Areas of Communications, Vol 21, No, 3 April 200*

www.agilent.com

Agilent Technologies' Test and Measurement Support, Services, and Assistance

Agilent Technologies aims to maximize the value you receive, while minimizing your risk and problems. We strive to ensure that you get the test and measurement capabilities you paid for and obtain the support you need. Our extensive support resources and services can help you choose the right Agilent products for your applications and apply them successfully. Every instrument and system we sell has a global warranty. Two concepts underlie Agilent's overall support policy: "Our Promise" and "Your Advantage."

Our Promise

Our Promise means your Agilent test and measurement equipment will meet its advertised performance and functionality. When you are choosing new equipment, we will help you with product information, including realistic performance specifications and practical recommendations from experienced test engineers. When you receive your new Agilent equipment, we can help verify that it works properly and help with initial product operation.

Your Advantage

Your Advantage means that Agilent offers a wide range of additional expert test and measurement services, which you can purchase according to your unique technical and business needs. Solve problems efficiently and gain a competitive edge by contracting with us for calibration, extra-cost upgrades, out-of-warranty repairs, and onsite education and training, as well as design, system integration, project management, and other professional engineering services. Experienced Agilent engineers and technicians worldwide can help you maximize your productivity, optimize the return on investment of your Agilent instruments and systems, and obtain dependable measurement accuracy for the life of those products.

Agilent Open

www.agilent.com/find/open

Agilent Open simplifies the process of connecting and programming test systems to help engineers design, validate and manufacture electronic products. Agilent offers open connectivity for a broad range of system-ready instruments, open industry software, PC-standard I/O and global support, which are combined to more easily integrate test system development.

For more information on Agilent Technologies' products, applications or services, please contact your local Agilent office.

Phone or Fax

United States:

(tel) 800 829 4444
(fax) 800 829 4433

Canada:

(tel) 877 894 4414
(fax) 800 746 4866

China:

(tel) 800 810 0189
(fax) 800 820 2816

Europe:

(tel) 31 20 547 2111

Japan:

(tel) (81) 426 56 7832
(fax) (81) 426 56 7840

Korea:

(tel) (080) 769 0800
(fax) (080)769 0900

Latin America:

(tel) (305) 269 7500

Taiwan:

(tel) 0800 047 866
(fax) 0800 286 331

Other Asia Pacific

Countries:

(tel) (65) 6375 8100
(fax) (65) 6755 0042
Email: tm_ap@agilent.com

Contacts revised: 05/27/05

**The complete list is available at:
www.agilent.com/find/contactus**

Product specifications and descriptions in this document subject to change without notice.

© Agilent Technologies, Inc. 2005
Printed in USA, September 16, 2005
5989-3443EN



Agilent Email Updates

www.agilent.com/find/emailupdates

Get the latest information on the products and applications you select.

MATLAB is a U.S. registered trademark of The Math Works, Inc.



Agilent Technologies